

P2050

OPERATING MANUAL



YAMAHA

ABOUT THIS MANUAL

SCOPE

The P2050 is a versatile, high quality audio power amplifier. It may be used as the sole amplifier in small sound systems, or as a complement to larger power amplifiers in bi- and tri-amplified systems. Like any power amplifier, the P2050's performance depends on system design and installation, in addition to its own capabilities. Thus, the P2050 Operator's Manual contains more than simple hook-up and operating instructions; it also covers system design parameters, installation techniques and applications.

Additionally, this manual reviews a few of the basic mathematic tools used in system design, from dB to Ohm's law.

ORGANIZATION

We recommend that you read the entire Operator's Manual. However, if you are using the P2050 in an existing system, and you are familiar with professional power amplifiers, the BRIEF OPERATING INSTRUCTIONS (Page ONE 1) contain all the information necessary for basic connections and operation.

The SPECIFICATIONS in sections THREE and FOUR, are highly detailed, including oscilloscope photos, and discussions of the P2050's excellent performance specifications. The last part of Section FOUR is a discussion of the advantages of genuine professional equipment, like the P2050, compared to hi-fi or professional consumer equipment.

The INSTALLATION AND DETAILED OPERATION section, which begins on Page SIX 1, includes more complete instructions, special considerations for using the P2050 "on the road," as well as in permanent commercial and studio installations. This section also covers grounding and shielding concepts, cabling considerations and several other topics.

The APPLICATIONS section, which begins on Page SEVEN 1, discusses the use of the P2050 in several typical setups, and includes wiring diagrams. This section also covers other devices that are normally associated with a power amplifier, from graphic equalizers to compressor/limiters.

The APPENDIX, on Page EIGHT 1, discusses definitions of a number of the terms used in the manual, and reviews some of the basic mathematic tools used in system design, such as the dB, Ohm's law, voltage division, and power formulas.

INDEX

THE P2050 – BRIEF OPERATING INSTRUCTIONS	SECTION ONE
INTRODUCTION	SECTION TWO
GENERAL SPECIFICATIONS	SECTION THREE
PERFORMANCE GRAPHS & A DISCUSSION OF SPECIFICATIONS	SECTION FOUR
THE DISTINCTION BETWEEN PROFESSIONAL AND HI-FI EQUIPMENT	SECTION FIVE
IMPEDANCE1
OPERATING LEVELS2
DYNAMIC RANGE2
GAIN OVERLAP AND HEADROOM4
INPUT SENSITIVITY RATINGS4
PROFESSIONAL EQUIPMENT ADVANTAGES4
INSTALLATION AND DETAILED OPERATION	SECTION SIX
PHYSICAL MOUNTING1
CABLING AND IMPEDANCE MATCHING2
ACTIONS OF THE P-2050 PROTECTION CIRCUITS13
GROUNDING AND SHIELDING13
AC: POWER, FUSES, ACCESSORY OUTLETS, WIRING, SAFETY16
MONO OPERATION17
APPLICATIONS	SECTION SEVEN
BIAMPLIFICATION AND TRIAMPLIFICATION1
ECHO, REVERB AND DELAY3
COMPRESSION AND LIMITING3
EQUALIZATION, HIGH AND LOW PASS FILTERS4
SPEAKER PROTECTION6
SPECIFIC APPLICATIONS7
APPENDIX	SECTION EIGHT
DEFINITION OF TERMS: dB, dBV, dBv, dBm and dB SPL1
SPECIAL USE OF dB (VOLTS) IN THIS MANUAL1
OHM'S LAW2
POWER2
IMPEDANCE3
SERIES AND PARALLEL IMPEDANCE CONNECTIONS3
VOLTAGE AND CURRENT DIVISION4
BALANCED, UNBALANCED, AND FLOATING CIRCUITS5
TRANSFORMERS5

SECTION ONE

BRIEF OPERATING INSTRUCTIONS

Fig. 1 – P2050 Front Panel

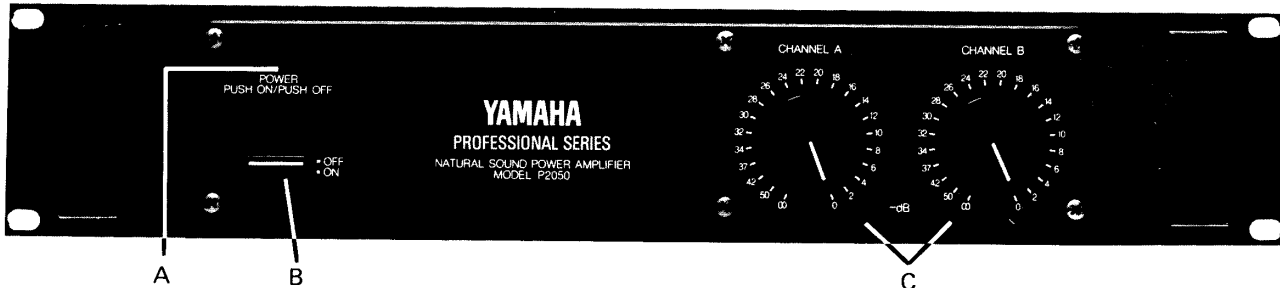

- A. Power Indicator**
Glowes when the Power Switch is "on."
- B. Power Switch**
Controls AC power to the P2050.

- C. Input Attenuators**
Calibrated, stepped input attenuators lower input signal levels ahead of any amplification stages.

NOTE:

The P2050 is made to be mounted in a standard 19" wide electronic equipment rack. It takes up 3-1/2" of vertical space, and extends 11-1/4" behind its front panel.

Fig. 2 – P2050 Rear Panel (U.S. Model)

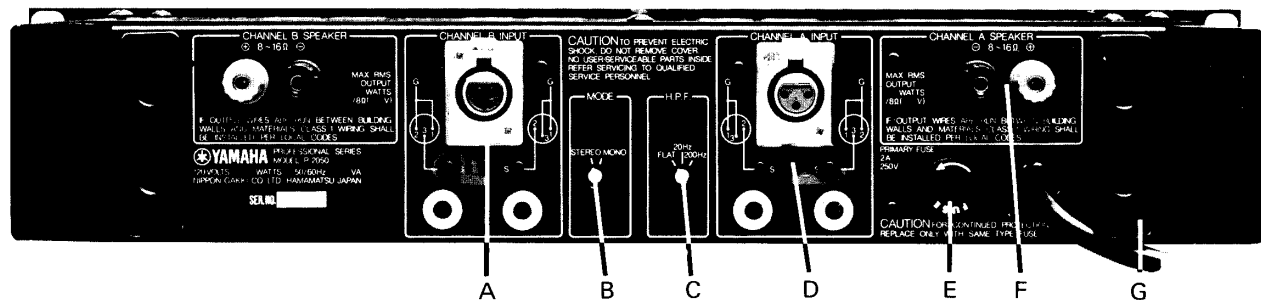

A. Input Connectors

The XLR input connector on each channel is unbalanced and is wired in parallel with the two adjacent phone jacks (tip/sleeve type).

B. Stereo/Mono Mode Switch

When using the P2050 as a stereo power amplifier, set this switch to STEREO position. If higher power output is desired and the program material is monaural, set the switch to MONO position and feed only the Channel A input. Then, by connecting the speaker cable across the red output terminals of the two channels (rather than the red and black terminals of one channel), the available power output to the speaker is more than doubled. (Use only CH A input attenuator.)

C. High Pass Filter Switch

With this switch set to FLAT, the P2050's output typically is down less than 1dB at 20Hz and less than 3dB at 10Hz, relative to the midband output. A 12dB/octave high pass filter (low cut filter) may be switched into the signal path of both inputs, with the 3dB down point set at 20Hz or 200Hz (actually 190Hz).

D. Input Polarity Switch

Determines the polarity of the two XLR input connectors (Pin 2 or Pin 3 "hot"); does not affect the two phone jacks. See diagram on P2050 rear panel.

NOTES:

1. Input impedance is 25k-ohms minimum; 0dB (0.775V RMS) produces 45 watts output into 8 ohms (19V RMS).

2. Input channels may be paralleled by connecting them together with phone plug to phone plug cables, as shown on Page SIX 7; not required for bridged mono operation, as STEREO/MONO MODE switch serves this purpose.

3. Input transformers for matching or isolation, should be located several inches from the P2050's power transformer for maximum hum rejection.

E. Fuse

3 amp, 250 volt, type AGC (3AG)*; fuse should always be replaced with same size and type. If the fuse blows consistently, the amplifier should be checked by a qualified Yamaha service technician.

F. Output Connectors

Standard 5-way binding posts (3/4" spacing) accept banana plugs or direct-wired connections. (U.S., Canadian and Australian models)

Conventional binding posts accept direct-wired connections. (other territories' models)

NOTES:

1. Continuous average sine-wave power output into 8 ohms is 45 watts per channel in STEREO mode, 95 watts total in MONO mode; power output rises at lower impedances.

2. Protection circuitry lowers power output when load impedance falls below 2.5 ohms in STEREO mode, or below 5 ohms in MONO mode.

G. AC Power Cord*

The P2050 requires a 120V AC50 or 60Hz line. (105V min., 135V max.; 1.8 amps max. at 120 volts)

NOTE:

For European model, an internal voltage selector (220V/240V switchable) is provided near the front panel. In this case 220V is factory-preset. If you want to change into 240V line, ask your Yamaha dealer.

* For U.S. and Canadian models only. For other territories' models, see the rear panel of the P2050.

SECTION TWO 1

INTRODUCTION

The P2050 complements Yamaha's higher powered, field proven power amplifiers. Its highly accurate sound, sophisticated design, professional features, and uncompromising performance make the P2050 an ideal companion to the P2100, P-2200 or P2201 in bi- or tri-amplified sound systems. The P2050 is also an excellent stand-alone power amplifier for smaller mono and stereo sound systems, as well as headphone distribution systems.

CALIBRATED INPUT ATTENUATORS

The P2050 has log-linear INPUT ATTENUATORS. The input attenuators are marked in 22 calibrated dB steps, detented for extra accuracy. The attenuators provide a smooth, noise-free transition from the highest to the lowest audio level. dB-calibrated input attenuators have numerous advantages: on the road, they allow predictable and repeatable setups; in commercial sound applications, they allow easy, accurate input sensitivity adjustments; in studios or discos, they let operators simultaneously adjust the level of two channels, or two programs on separate amplifiers, with precise tracking.

INPUT AND OUTPUT CONNECTIONS

INPUT CONNECTORS for each channel include one "female" XLR connector (unbalanced) plus two phone jacks, all wired in parallel. This provides the flexibility necessary for convenient bridging to another amplifier, as well as for adapter-free connection to almost any mixer. A POLARITY switch allows either pin 2 or pin 3 of the XLR to be chosen as the "hot" lead, satisfying DIN/JIS or USA standards. Outputs are standard five way binding posts, usable with reliable "banana" plugs or direct wired connections on U.S., Canadian and Australian models only. On other territories' models output binding posts accept direct wired connections.

MONAURAL OPERATION

The P2050 may be converted to a higher power monaural amplifier with the flick of a handy rear-panel MODE switch. Placing the unit in MONO mode establishes a transformerless balanced output, the speaker load "bridged" across the "hot" terminals of both channels. In this mode the P2050 delivers twice the voltage to the speaker load. Since the minimum load impedance is also doubled when switched to MONO mode, the power available to a single output load is about twice that available in STEREO mode.

PERFORMANCE

The P2050's performance is impressive, audibly and in laboratory measurements. The unit is conservatively rated at 45 watts into 8 ohms (for each channel). Even at full output power, this amplifier sounds clean and open. Because the P2050 has the ability to sustain full power output, it is well suited to use in live rock or disco sound systems, where an amplifier can really "cook" all night long. While prolonged full power operation does not qualify an amplifier for professional acclaim, doing so with truly low noise and distortion is another story.

The P2050 is very nearly the ideal "straight wire with

gain." It measures less than 0.05% THD at full rated power (typically less than 0.02% THD and less than 0.03% IM). This ultra-low distortion is under the residual noise floor of many analyzers, and is virtually undetectable by even the most critical listeners.

A high damping factor of better than 100 at frequencies below 1kHz reduces the tendency for speaker cone overshoot, giving tighter and better defined speaker response; a high damping factor (i.e., low output source impedance) also ensures efficient power transfer to the speakers. Because the P2050's frequency response extends well beyond 50kHz, the unit will accurately reproduce the most complex musical waveforms — even the tortuous output of today's synthesizers. However, high frequency response has not been achieved at the expense of stability; in fact, the P2050 is rock steady. Even when connected to highly reactive speaker loads, there is no tendency to shut down or "take off" into spurious oscillation.

MECHANICAL DESCRIPTION

The P2050 is constructed to withstand the high "G" forces encountered on the road. The unit weight 16 pounds (7.2kg) and has a solid front panel that mounts in any standard 19-inch rack. Front panel controls are recessed to avoid damage or accidental setting changes, and are further protected by a pair of sturdy carrying handles. Inside and out, the P2050 is extremely reliable. Still, should service ever be required, the unit is designed for easy access. Massive side-mounted heat sinks are designed for efficient cooling, making fans unnecessary in all but the most severe thermal operating conditions. Four non-conductive feet ensure proper air flow when the amplifier is shelf mounted, and avoid inadvertent ground loops. Multiple protection circuits make the amplifier nearly abuse proof and eliminate the need for troublesome DC power supply fuses.

SECTION THREE¹

GENERAL SPECIFICATIONS

Power Output Per Channel: (Refer to Figure 3)

45 watts continuous average sine wave power into 8 ohms with less than 0.05% THD, over a bandwidth of 20Hz to 20kHz, both channels driven.

Frequency Response: (Refer to Figure 5)

+0dB, -1dB, 20Hz to 50kHz.

Total Harmonic Distortion: (Refer to Figures 6 - 8)

Less than 0.01% @ 25 watts, 8 ohms, 1kHz.
Less than 0.02% @ 25 watts, 8 ohms, 20Hz to 20kHz.

Intermodulation Distortion

Less than 0.03% using frequencies of 70Hz and 7kHz, mixed in a ratio of 4:1, single channel power output of 25 watts into 8 ohms.

Input Sensitivity

An input of 0dB* (0.775V), ± 0.5 dB, produces an output of 45 watts into 8 ohms, INPUT attenuator set for maximum level.

Input Impedance: (Refer to Figure 10A)

25kohms, minimum (unbalanced).

Actual Output Impedance: (Refer to Figure 10B)

Less than 0.08 ohms from 20Hz to 1kHz; less than 0.18 ohms from 20Hz to 20kHz.

Damping Factor: (@ 8 ohms) (Refer to Figure 9)

Greater than 100 at any frequency from 20Hz to 1kHz; greater than 45 at any frequency from 20Hz to 20kHz.

Hum and Noise

At least 110dB signal-to-noise ratio (I.H.F./A.S.A. #Z24.3-1944).

Rise Time

3.8 microseconds, or better (10% - 90% of 1 volt @ 1kHz square wave output).

Slew Rate

15 volts per microsecond, or better (at 30 watts into 8 ohms, 200kHz square-wave input).

Channel Separation: (Refer to Figure 11)

At least 82dB at 1kHz, at least 70dB at 20kHz.

Phase Shift: (Refer to Figure 12)

20Hz to 20kHz, ± 10 degrees.

Offset Voltage

Less than ± 30 mV DC.

Unit Step Function Response

See scope photo (Figure 20, Page FOUR 4), and discussion (Page FOUR 6).

Thermal Characteristics

Massive black anodized heat sinks are thermally joined with the chassis, thereby utilizing the entire amplifier as a heat sink.

Protection Circuits

A self-resetting thermal switch shuts down the AC power if the power transformer winding temperature reaches 130 degrees Centigrade. See Page SIX 13 for power overload circuit discussion.

Turn On/Turn Off Characteristics

There is no turn off transient; the turn on transient is minimal (see Page SIX 13). Warm up time is less than 0.2 seconds.

Power Requirements (Refer to Figure 13)

AC, 120 volts nominal, 50-60Hz (105V min., 135V max.); 1.8 amperes maximum at 120VAC; 216 volt-amperes maximum at 120 volts; approximately 25 volt-amperes at idle.**

Efficiency: (Refer to Figure 13)

As high as 52%.

Input Connectors

One "female" XLR connector, pin 2 "hot", pin 3 connected to pin 1 (shield); switchable for pin 3 "hot". XLR is unbalanced and in parallel with two tip-sleeve (standard) phone jacks.

Output Connectors

Standard 3/4-inch spacing, "5-way" binding posts. (U.S., Canadian and Australian models)
Conventional binding posts. (other territories' models)

Indicator

"Power ON" indicator LED.

Controls

INPUT ATTENUATORS (one per channel)
22-position, log-linear, detented and dB-calibrated; they attenuate input signal in 2dB steps from 0dB attenuation to -34dB, then steps of -37dB, -42dB, -50dB, infinity.

POWER switch (ON/OFF).

INPUT POLARITY switches.

HIGH PASS FILTER switch; FLAT, 20Hz low cut or 200Hz low cut @ 12dB/octave.

MODE switch (MONO/STEREO).

Fuse

AGC (3AG) type, 3-amp fuse for the AC line input.**

Dimensions

Mounts in a standard 19-inch (48 cm) rack. 3-1/2" high (8.8 cm); maximum depth behind front panel is 11-1/4" (28.5 cm); maximum depth including front handles 12-5/8" (32.0 cm).

Weight

16 Pounds (7.2 kg).

Color

Semi-gloss black.

* In these specifications, when dB represents a specific voltage, 0dB is referenced to 0.775V. "dBm" denotes a power level, whereas "dB" denotes a voltage level which is referenced to the voltage measured across 600 ohms. 0dBm is referenced to 1mW (0.775V RMS driving a 600-ohm termination). For example, when 12.3V is fed to a high impedance, the level is designated "+24dB". When +24dB (12.3 volts) drives a 600-ohm termination, the level is designated "+24dBm". The level in "dB" is specified, wherever applicable, to avoid confusion when the input is fed by various low and high impedance sources. See the APPENDIX beginning on Page EIGHT 1 for a further discussion of dB.

** For U.S. and Canadian models only. For other territories' models, see the rear panel of the P2050.

THREE²

MONAURAL MODE SPECIFICATIONS

Power Output: (Refer to Figure 14)

95 watts continuous average sine wave power into 16 ohms with less than 0.05% THD, 20Hz to 20kHz.

Frequency Response

+0dB, -1dB, 20Hz to 50kHz.

Total Harmonic Distortion: (Refer to Figures 16 & 17)

Less than 0.01% @ 50 watts into 16 ohms at 1kHz.

Intermodulation Distortion

Less than 0.05% using frequencies of 70Hz & 7kHz, mixed in a ratio of 4:1, at a power output of 50 Watts into 16 ohms.

Input Sensitivity

An input of 0dB (0.775 volts), ± 0.5 dB, produces an output of 95 watts into 16 ohms, INPUT attenuator set for minimum attenuation (maximum level).

Input Impedance

25 kohms minimum (unbalanced).

Damping Factor: (@16 ohms)

Greater than 200 at any frequency from 20Hz to 1kHz; greater than 90 at any frequency from 20Hz to 20kHz.

Hum and Noise

At least 110dB signal-to-noise ratio (I.H.F./A.S.A. #Z24.3-1944).

Slew Rate

25 volts per microsecond, or better, at 30 Watts into 16 ohms, 200kHz square wave input.

NOTE: All performance specifications are made on U.S. and Canadian models at an AC line voltage of 120 volts $\pm 1\%$, using a $\pm 1\%$ non-reactive load resistor at an ambient room temperature of 25-degrees Centigrade. Also effective for other territories' models.

SECTION FOUR¹

PERFORMANCE GRAPHS & A DISCUSSION OF SPECIFICATIONS

NOTE: In the discussion beginning on Page FOUR 5, references to specific specifications assume normal stereo operation (not mono operation) unless otherwise indicated.

Normal (Stereo) Graphs

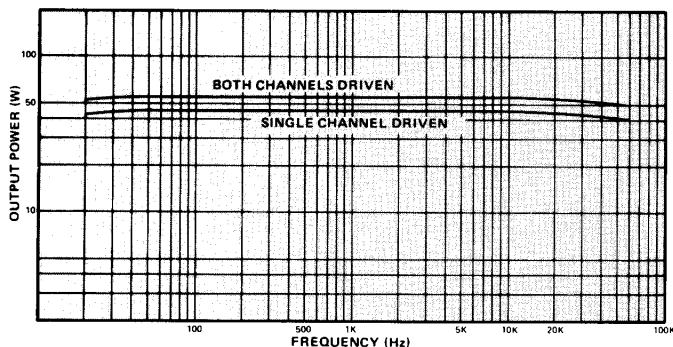

Fig. 3 - Power Bandwidth 8Ω @ 0.5% T.H.D.

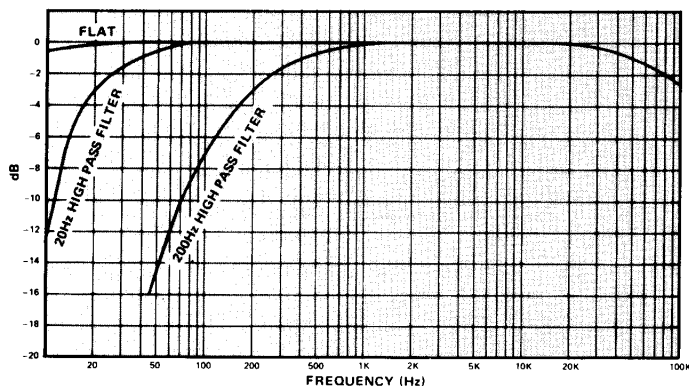

Fig. 5 - Frequency Response

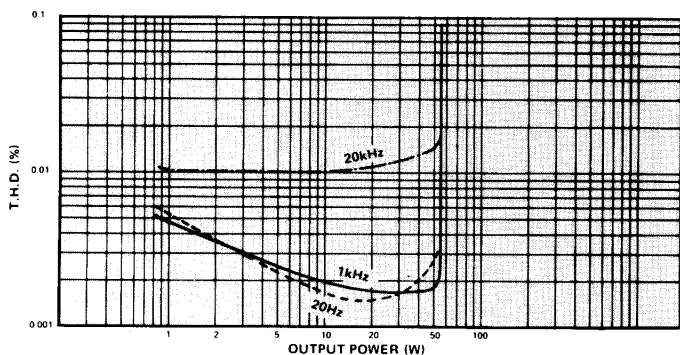

Fig. 7 - T.H.D. vs Output Power at 8Ω Load Impedance (single channel driven)

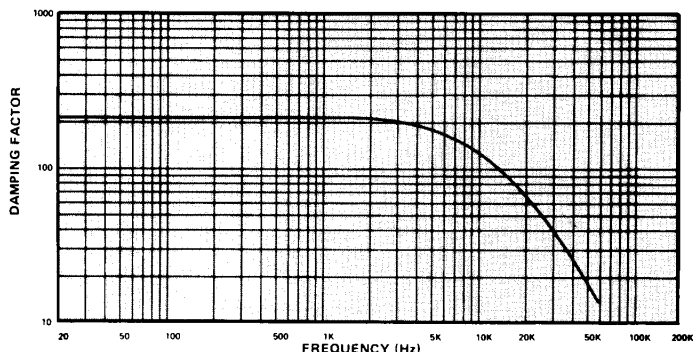

Fig. 9 - Damping Factor vs Frequency at 8Ω Load Impedance

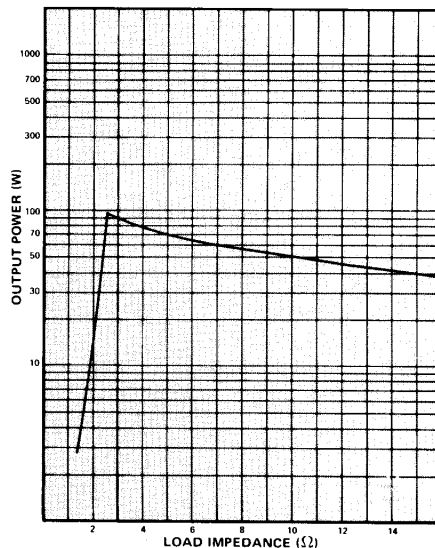

Fig. 4 - Output Power vs Load Impedance (Resistive) (stereo mode single channel driven)

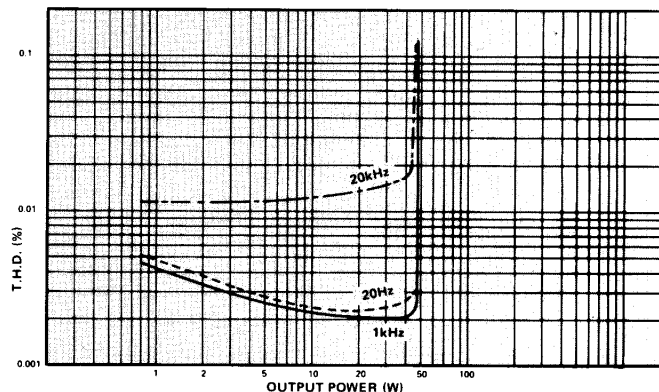

Fig. 6 - T.H.D. vs Output Power at 8Ω Load Impedance (both channels driven)

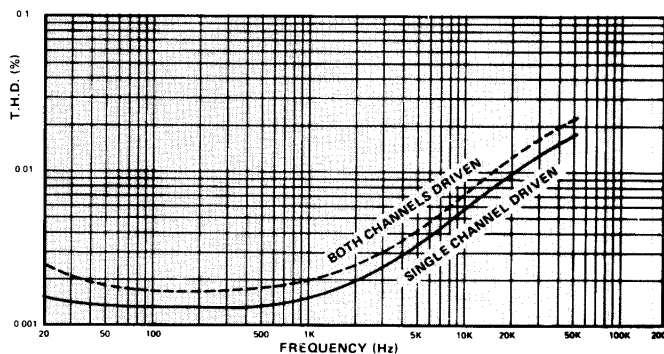

Fig. 8 - T.H.D. at 8Ω Load Impedance

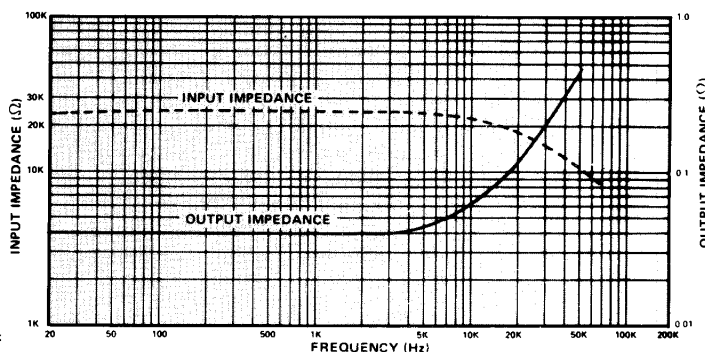

Fig. 10 - Impedance vs Frequency at 8Ω Load Impedance

FOUR²

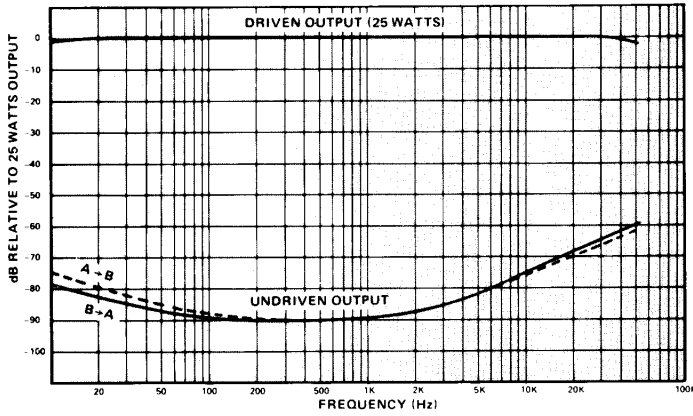

Fig. 11 - Crosstalk (Input Attenuator 0dB at 8Ω Load Impedance)

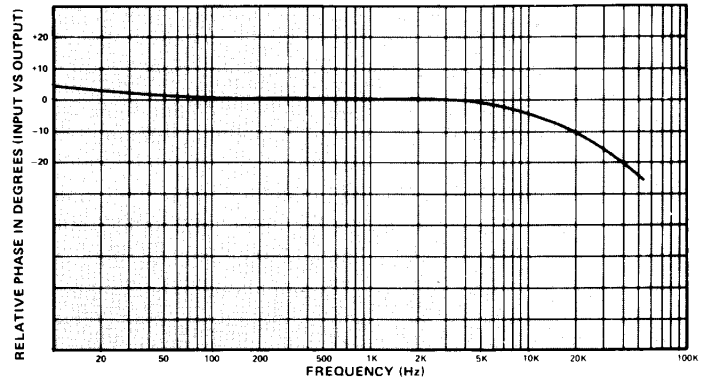

Fig. 12 - Phase Response R_L at 8Ω

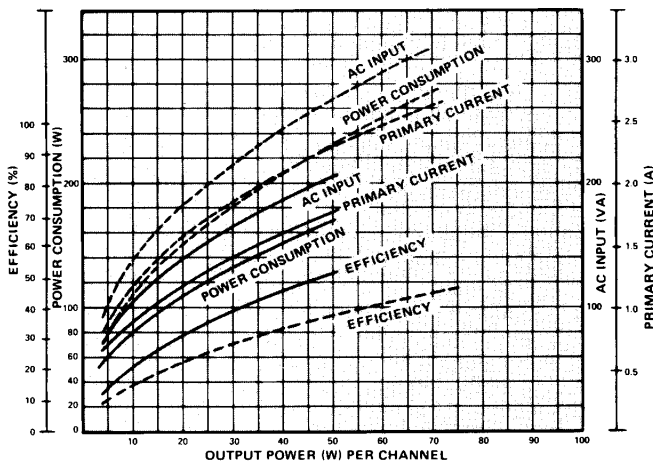

Fig. 13 - Output Power/Power Consumption (dotted line = 4Ω / solid line = 8Ω)

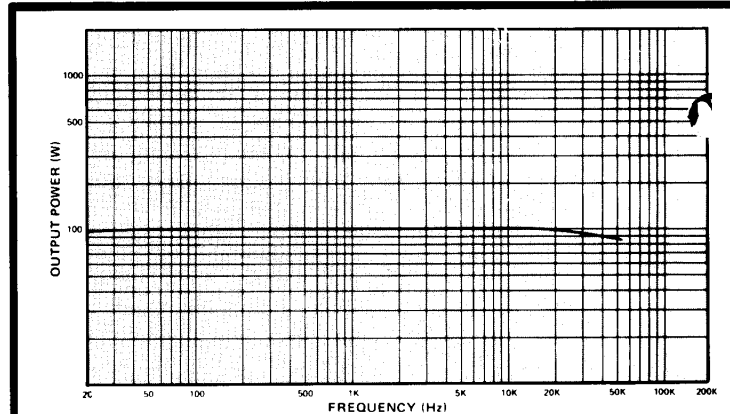

Fig. 14 - Power Bandwidth Mono 16Ω at 0.05% T.H.D.

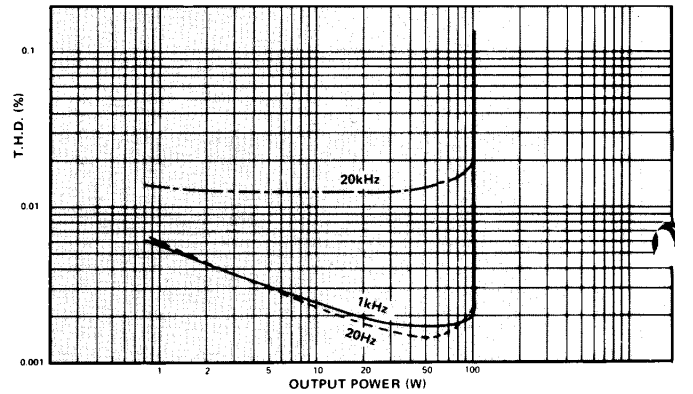

Fig. 16 - T.H.D. vs Output Power (Mono Mode) at 16Ω load Impedance

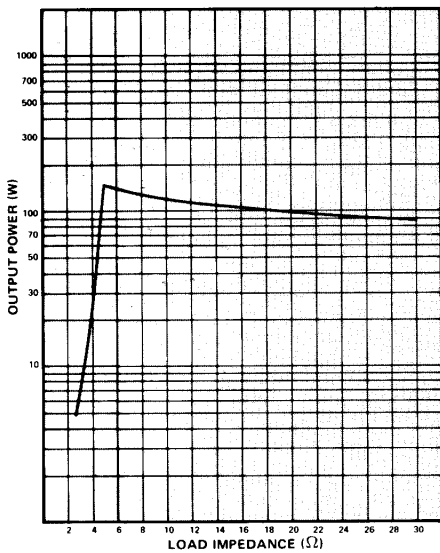

Fig. 15 - Output Power vs Load Impedance (resistive)

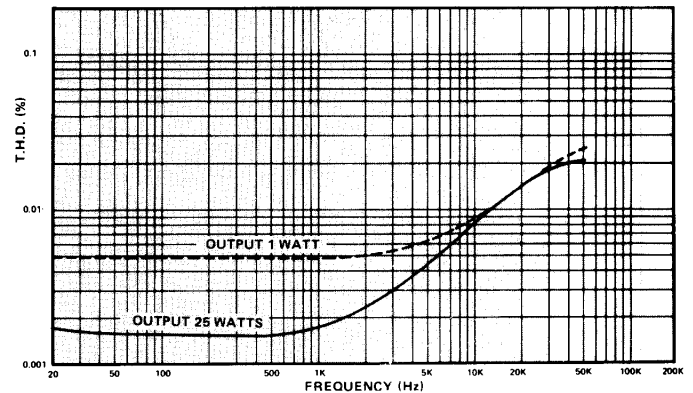

Fig. 17 - Total Harmonic Distortion (R_L at 16Ω)

Mono Mode Graphs

The following are actual oscilloscope photographs made by an independent testing laboratory. The close vertical alignment of input and output traces in Fig. 18C through 19A depicts very low phase shift, so the amplifier will not alter musical wave shapes.

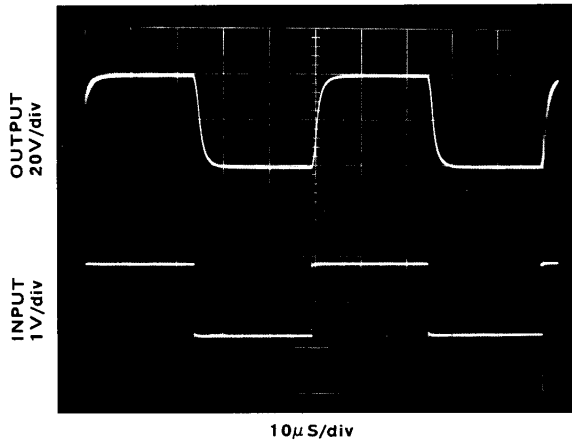

Fig. 18A — 20,000Hz Square Wave Response
The extremely fast and symmetrical rise and fall times of the amplifier are evident, demonstrating the ability to reproduce accurately musical waveforms and harmonics well beyond the range of human hearing.

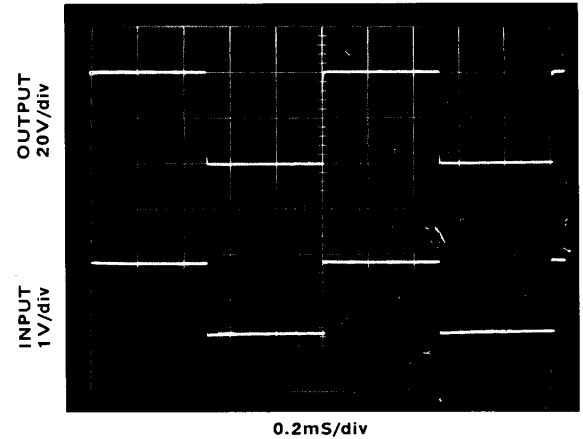

Fig. 18B — 1,000Hz Square Wave Response
Near perfect response is evident in the duplication of the input waveform by the output waveform. There are no "squiggles" or spikes, meaning there is no ringing or overshoot.

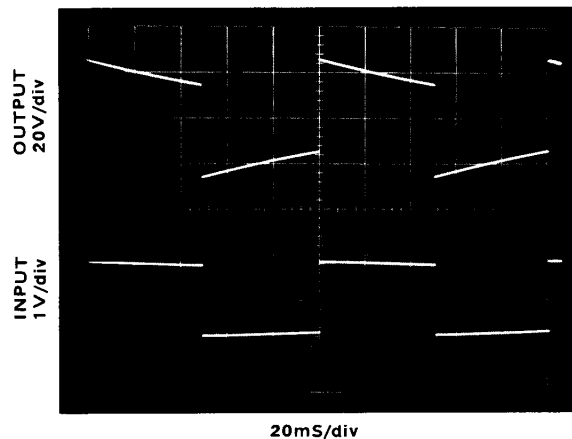

Fig. 18C — 10Hz Square Wave Response
The output waveform displays very respectable low frequency response. The slight "tilt" shows a DC gain of unity, which prevents damage to speakers in the event any DC offset is fed to the amplifier input.

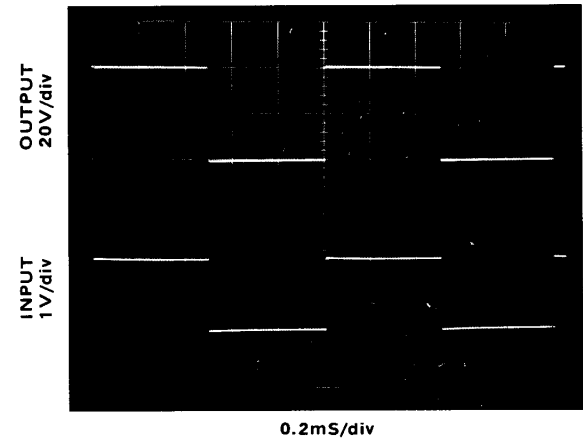

Fig. 18D — Square Wave Response into a Highly Inductive Load (at 1kHz)
The P2050's ability to maintain a sharply defined square wave output into a reactive load demonstrates stability under the worst conditions. There is still a complete lack of unwanted ringing, as well as virtually unmeasurable phase shift.

FOUR4

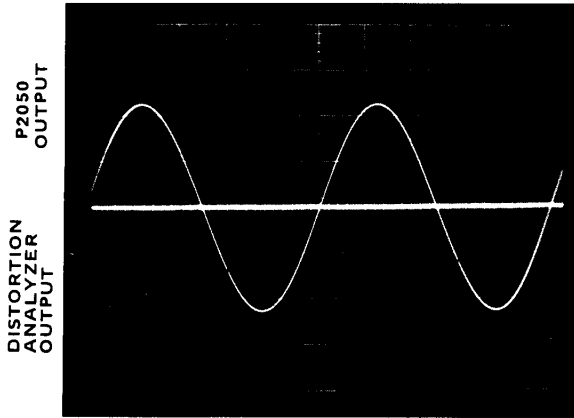

Fig. 19A – 1,000Hz Sine Wave Shown with Highly Magnified Noise and Distortion Components

At 30 watts output (8 ohms) the P2050's distortion is so low (0.0034%) that it is almost buried in the noise. The sine wave is clean and symmetrical.

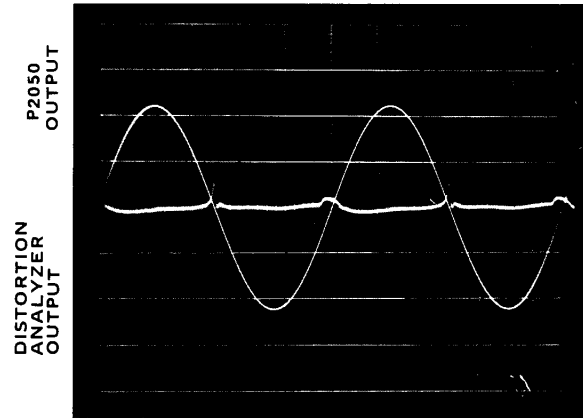

Fig. 19B – 20,000Hz Sine Wave Shown with Highly Magnified Noise and Distortion Components

Even at 20kHz, the P2050 yields clean, symmetrical low distortion amplification (0.0106% THD @ 30 watts into 8 ohms).

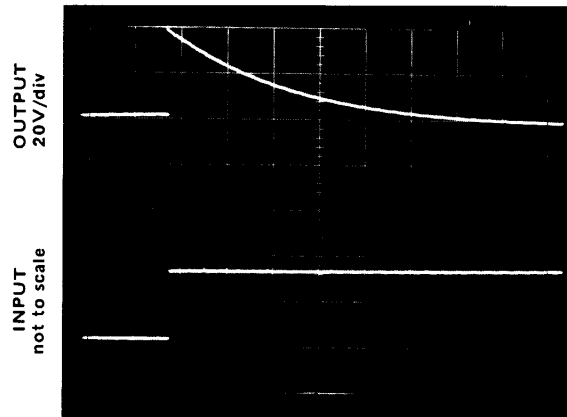

Fig. 20 – Unit Step Function Response

POWER OUTPUT

Types of Power Ratings

Peak power refers to the maximum undistorted power output of an amplifier. Most amplifiers cannot sustain their peak power ratings for long periods of time without external cooling fans. Because there are many different methods of rating an amplifier's peak power, it is hard to objectively compare the peak power ratings of two amplifiers. The peak power rating is primarily useful for determining an amplifier's ability to reproduce the peaks and transients in a musical program, peaks which may be 20dB or more above the average power level. The ability to accurately reproduce these high power peaks in a musical program is one of the most important advantages of the P2050 as compared to a smaller power amplifier.

"RMS" power is actually a misnomer for *average power*. Average power is usually measured with a sine wave input signal, and is equal to the amplifier's rms output voltage squared and then divided by the load impedance (see Appendix). Because rms voltage is used in the formula, the resulting power rating is commonly called "rms power." To be more accurate, the P2050 is rated in watts of "continuous average sine wave power," which is calculated from the rms voltage across a known load.

Since the P2050 is a *professional* power amplifier, not sold for home hi-fi use, it is not required to meet the power rating standard set by the FTC (Federal Trade Commission), a standard meant for *consumer* power amplifiers. However, the P2050 is measured under severe conditions which simulate the most demanding *professional* usage. Thus, the P2050 would easily meet the FTC ratings for consumer amplifiers. In addition, the P2050 user has the benefits of professional features and reliability.

Power Output versus Load

Within its maximum limits, the P2050 acts like a perfect voltage source (see Appendix). That is, its power output rises with decreasing load impedance. When the load impedance drops below 2.5 ohms, the P2050's protection circuits begin to limit the power, resulting in the curve shown in Figure 4 (normal operation) and Figure 15 (mono operation).

DISTORTION (Refer to Figures 6, 7, 8, 16 & 17)

The P2050 is designed to have the lowest possible distortion. There are many different forms of distortion, however, and comprehensive distortion ratings offer a means to compare the performance of different amplifiers.

Harmonic distortion is characterized by the appearance at the amplifier output of *harmonics* of the input waveform which were not present in the *original* input waveform. *Total Harmonic Distortion*, or T.H.D., is the sum total of all of these unwanted harmonics expressed as a percentage of the total signal.

Harmonic distortion in an amplifier can be created in any of several ways. The T.H.D. rating of a power amplifier refers to creation of unwanted harmonics by the amplifier during "linear" operation (normal input and output levels, impedances, etc.). Harmonic distortion is also created by "clipping," a form of "non-linear" operation which occurs when the signal level at an amplifier's input is high enough to drive the amplifier beyond its rated maximum output. The amplifier, in attempting to reproduce this signal, reaches its maximum output voltage swing before it reproduces the top of the signal waveforms. Since the output voltage cannot rise

any farther, the tops of the waveform are "squared off," or clipped, as that shown in Figure 58, Page SEVEN 1. Clipping distortion adds odd upper harmonics (3rd, 5th, etc.) to the original signal. Input clipping, where the input stage of the amplifier is overdriven by a high level input signal, would be similar. The P2050 has wide input headroom and extremely high peak power output capabilities (headroom) to help avoid the problems of clipping distortion.

Another form of harmonic distortion that occurs in some power amplifiers is called *crossover distortion*. * Crossover distortion is caused by improper bias in the output transistors of an amplifier. The *amount* of crossover distortion stays the same whether the signal is large or small, so the *percentage* of distortion goes down as the signal level goes *up*. Thus, an amplifier with crossover distortion may sound relatively distortion free at high output levels, yet sound "fuzzy" at low levels. Some amplifiers have internal adjustments which enable a service technician to control the amount of output transistor bias, and therefore control the distortion. The P2050 has automatic biasing circuitry which needs no adjustment and avoids crossover distortion under all operating conditions.

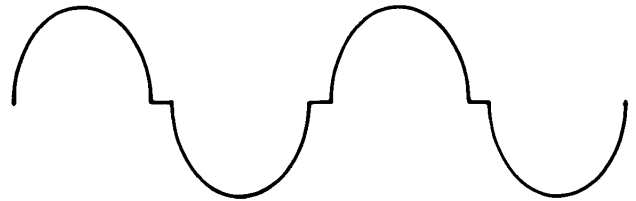

Fig. 21A — Large Amplitude Sine Wave with Crossover (notch) Distortion.



Fig. 21B — Smaller Amplitude Sine Wave with same amount (higher %) of Crossover (notch) Distortion.

Intermodulation distortion, or I.M., is characterized by the appearance in the output waveform of frequencies that are equal to sums and differences of integral multiples of two or more of the frequencies present in the input signal. The difference between intermodulation distortion and harmonic distortion is that two or more different frequencies must be present to produce intermodulation distortion, and that intermodulation distortion products may not be harmonically related to the original frequencies. (Only one frequency is needed for harmonic distortion to appear.) Like its harmonic distortion figure, the intermodulation distortion in the P2050 is low enough to be virtually inaudible even in the most critical situations.

Dynamic Frequency Response Shift is related to both harmonic and intermodulation distortion. When high level low and high frequency signals are present in the same waveform, the high frequency signals "ride" on top of the low frequency waveforms (See Figure 58, Page SEVEN 1). If amplifier headroom is inadequate, the low frequencies may "push" the high frequencies above the output limits of the amplifier, clipping them off the waveform (Figure 58C). The low frequencies may

*"Crossover," in this case, refers to the transition between the positive half and the negative half of the output voltage waveform in a "push pull" class B or AB power amplifier; it has nothing to do with the crossover used to divide frequencies in a speaker system. See Figure 21.

FOUR6

remain unaltered, but the high frequencies are severely reduced. At the same time, harmonics of the high frequencies are produced which add to the super high frequency content of the signal. Thus, along with the distortion created by the clipping, the frequency response of the original signal is drastically altered. This type of distortion can be reduced by increasing system headroom (using a more powerful amplifier, and by bi-amplifying the system as discussed on Page SEVEN 1.

The extremely low distortion figures of the P2050 indicate its overall quality and mean that its sound will be precise and natural.

FREQUENCY RESPONSE (Refer to Figure 5)

The *frequency response* of the P2050 describes the variation in its output signal level with frequency when the input signal is held constant. The extremely "flat" frequency response curve of the P2050 is an indication of its overall quality and its ability to respond to upper and lower harmonics of signals all the way to the extremes of the audio spectrum.

Because good stability is necessary for some types of commercial sound applications, notably constant-voltage commercial sound speaker lines, some manufacturers restrict frequency response or allow relatively high distortion in return for increased amplifier stability. The P2050, on the other hand, has excellent frequency response and ultra-low distortion, yet is inherently stable under the most difficult loads, even in the "mono" mode.

The frequency response of the P2050 has been intentionally limited, however, at very low, subsonic frequencies. Because of this, severe low frequency transients, or DC offset, appearing at the input to the P2050 are unlikely to damage a speaker load. Other amplifiers which are DC coupled throughout may have a "flatter" subsonic frequency response, but this makes them capable of amplifying dangerous DC input voltages or sub-audio transients and delivering them (at high power) to a speaker.

The P2050's rear-panel High Pass Filter switch permits the user to restrict the amplifier's low frequency response, a decided advantage in certain applications. "Flat" position switches the filter out of the circuit entirely so the amplifier's output is down less than 1dB relative to its midband output. In "20Hz" position, the filter cuts the 20Hz level by 3dB, and below 20Hz the response rolls off at 12dB/octave; the 10Hz level would be down approximately 15dB (3dB + 12dB), preventing inaudible sub-sonics from wasting headroom or damaging woofers. Since there is seldom any program material at 20Hz, and most speakers do not function well in the region, the "20Hz" roll off is more likely to improve the sound than to detract from it. In "200Hz" mode, the filter's "knee" moves up so that 190Hz is down 3dB. Since the same 12dB/octave slope applies, 95Hz is down 15dB, 47.5Hz is down 27dB, 24Hz is down 39dB, etc. This more drastic filter action is suitable when the amplifier is used to reproduce mid or high frequencies in a bi- or tri-amplified system because the filter further protects high frequency drivers from over-excitation. The "200Hz" high pass filter is also desirable in voice-only paging applications, where little program exists below 200Hz, and exclusion of the low frequencies permits higher average volume levels to be used with less wear and tear on the speakers.

OFFSET VOLTAGE

This specification indicates the amount of DC

voltage naturally present at the output of the amplifier. A high DC voltage could damage the loudspeaker load; the $\pm 30\text{mV}$ (30 one-thousandths of a volt) level from the P2050 is insignificant.

UNIT STEP FUNCTION RESPONSE (Refer to Figure 20)

A unit step function is like the leading edge of a square wave; it goes up, but never comes down. The response to this input indicates the output of the P2050 for a DC input signal which might come from a faulty direct coupled preamplifier, or mixer. Note that the P2050 will not reproduce a DC voltage fed to its input, thus adding an extra measure of loudspeaker protection.

POWER BANDWIDTH (Refer to Figures 3 & 14)

The *power bandwidth* of the P2050 is a measure of its ability to produce high power output over a wide frequency range. The limits of the power bandwidth are those points where the P2050 can only produce 1/2 the power that it can produce at 1000Hz. While the frequency response is measured at relatively low power output (1 watt), the power bandwidth is measured at the P2050's full power output (before clipping). The power bandwidth of the P2050 is quite "flat," and extends to 50kHz, well beyond the limits of the audio spectrum.

The wide power bandwidth of the P2050 means that it can reproduce high level upper harmonics of a signal as easily as it can reproduce mid-range fundamentals. It means that you get full power performance from the P2050 over the entire audio frequency spectrum. This is especially important when the amplifier is called upon to reproduce musical material with high energy over a wide frequency range, such as rock and roll.

PHASE RESPONSE (Refer to Figure 12)

The *phase response* of the P2050 is a measure of the amount of time delay it adds to different frequencies. An amplifier with perfect phase response would introduce equal time delay at all frequencies reproduced. The P2050's worst case phase shift of -10 degrees at 20kHz corresponds to a 1.4 microsecond (1.4 millionths of a second) delay period which is insignificant in even the most critical audio applications.

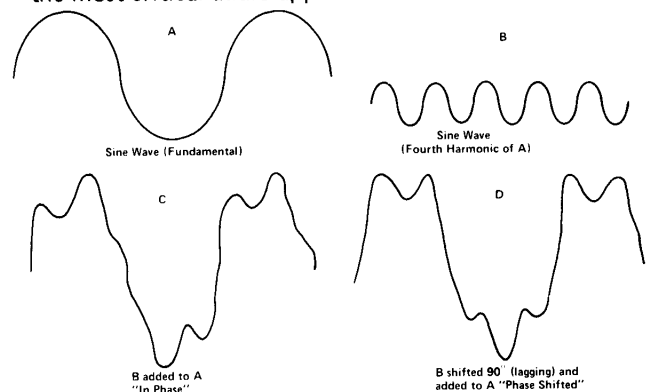

Fig. 22 – Waveform of Amplifier with Poor Phase Response.

An amplifier with poor phase response would change the shape of a waveform that was made up of a fundamental frequency and several harmonics by delaying each harmonic differently. The effect might be similar to that shown in Figure 22.

CHANNEL SEPARATION (Refer to Figure 11)

This specification indicates the output from one channel when a signal is fed to the other channel. The P2050's channel separation is very good, which means that even critical stereo programs will be unaffected by crosstalk between channels.

HUM AND NOISE

Hum or noise from a power amplifier disrupts a program, and is irritating to a listener. Hum and noise could be considered a form of distortion. The P2050's hum and noise are so low that they are completely inaudible under any normal listening circumstances.

RISE TIME

Rise time is a measurement of the amount of time an amplifier requires to respond to a square wave at a specified frequency. The rise time of an amplifier is an indication of its frequency response. A fast rise time corresponds to a wide frequency response. The P2050's rise time specification is measured with a 1000Hz square wave output signal of one volt peak-to-peak amplitude. The rise time is the time the amplifier requires to change from 10% (0.1 volt) to 90% (0.9 volt) of its output. The first and last 10% are normally not included in the test because any slight non-linearities that occur in this portion of the test signal or the amplifier could lead to measurement error. Thus, a 10%-90% figure improves measurement accuracy.

SLEW RATE

Slew rate is a measure of the ability of the amplifier to follow a fast rising waveform at higher frequencies and higher power outputs than the rise time measurement. The P2050's slew rate is measured with a 200kHz square wave input signal, at 30 watts output power into 8 ohms (stereo operation).

It might seem reasonable to assume that the fastest slew rate for an audio waveform occurs at 20kHz. However, this is not the case. When one frequency is superimposed upon another, the combined waveform has a slew rate that is greater than the slew rate of either signal by itself. The actual value of the slew rate of one of these waveforms, or of any waveform, depends not only on the frequency, but on the amplitude of the waveform as well. Thus, the criteria for a good slew rate specification, which indicates that an amplifier can reproduce these combination waveforms, varies with the maximum power output capability of the amplifier. The higher the power, the higher the required slew rate. With a 15 volt/microsecond slew rate, the P2050 can easily reproduce even the most extreme audio waveforms at its full power output.

INPUT IMPEDANCE

The *input impedance* of the P2050 is high enough to allow it to be used with most semi-pro devices, or to be used as a "bridging" load for a 600-ohm source. Page SIX 2 details input impedance and level matching for the P2050.

INPUT SENSITIVITY

The P2050's *input sensitivity* indicates the input drive voltage needed for the P2050 to produce 45 watts into 8 ohms with input attenuators adjusted to maximum clockwise rotation for minimum attenuation.

PROTECTION CIRCUITS AND THERMAL CHARACTERISTICS

See the discussions under INSTALLATION, on Page SIX 13.

GAIN

Gain is the ratio of the P2050's output voltage to its input voltage. Maximum gain occurs when the input attenuators are set for minimum attenuation. If the input and output voltage are specified in dB, the voltage gain is equal to the difference of the two dB numbers. As stated under INPUT SENSITIVITY, an input voltage of 0dB (0.775 volts) produces an output

power of 45 watts into an 8-ohm load. 45 watts into 8 ohms implies an output voltage of 19 volts, which corresponds to +28dB. dB is referenced to 0.775 volts, as used in this manual. Thus, the voltage gain of the P2050, with its input attenuators set for minimum attenuation, is 28dB (+28dB - 0dB = 28dB).

NOTE: 45 watts is +46.5dBm.

OUTPUT IMPEDANCE (Refer to Figure 10)

The *output impedance* of the P2050 is extremely low. Thus, within its operating limits, the P2050 is a good approximation of a perfect voltage source and will deliver increasing power levels into lower impedance loads in a linear fashion according to Ohm's law. The appendix discusses Ohm's law and the concept of a perfect voltage source.

DAMPING FACTOR (Refer to Figure 9)

Damping factor is a term that is derived by dividing the load impedance (speaker or other load) by the amplifier's output impedance. Thus, a high damping factor indicates a low output impedance at a specified load.

The cone/voice-coil assembly of a loudspeaker gains inertia during its back and forth movements. This inertia can cause it to "overshoot," that is, to continue movement in one direction, even when the amplifier is trying to pull it back in the other direction. An amplifier with a low output impedance can "damp" (reduce) unwanted loudspeaker motions, as explained below.

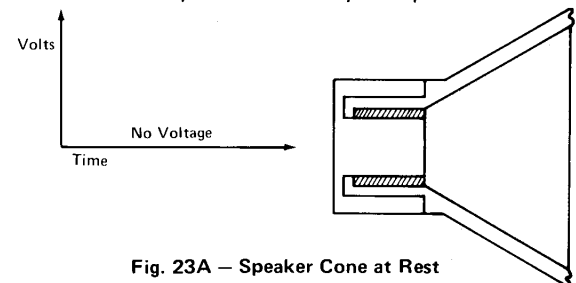

Fig. 23A — Speaker Cone at Rest

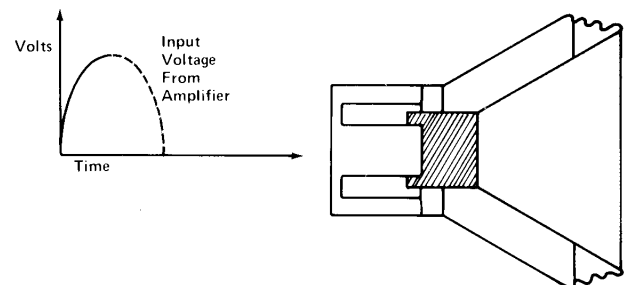

Fig. 23B — Speaker Cone moved outward by Positive-Going Voltage from Amplifier.

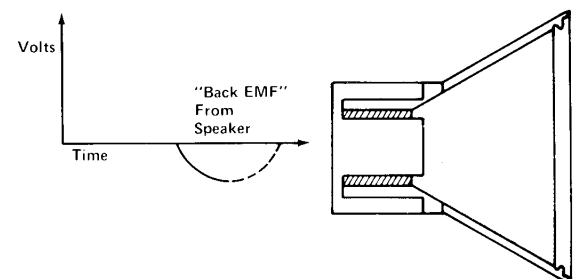

Fig. 23C — Voltage from Amplifier has dropped to Zero and Speaker Cone has moved back PAST its rest position (overshoot) and is producing a voltage of its own: "Back EMF"

FOUR8

During the "overshoot" movement, the voice coil of the loudspeaker interacts with the loudspeaker's magnetic assembly to produce a voltage called "back E.M.F." (electromotive force). This action is similar to the operation of a dynamic microphone. If the amplifier's output impedance is low, this "back E.M.F." voltage is shunted through the amplifier's output circuits to ground, and back to the voice coil. Since the path from the voice coil, through the amplifier's output circuits, and back to the voice coil is a complete circuit, a current flows in the voice coil. This current causes the voice coil to act like an electro-magnet; the electro-magnet interacts with the magnetic assembly of the loudspeaker, and the unwanted overshoot is reduced by a magnetic braking action.

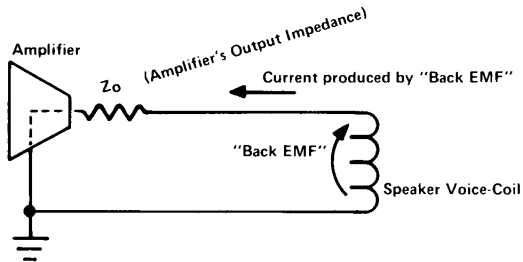

Fig. 24 – Current produced by "Back EMF" follows path through Amplifier's Output Impedance to speaker-coil.

If the amplifier's output impedance is low, considerably less than the impedance of the loudspeaker voice coil, this damping action is limited only by the resistance of the voice coil combined with the resistance of the speaker lead wires. While the value of a high damping factor in reducing cone overshoot is disputed, the P2050's high damping factor is evidence of good overall engineering design.

THE DISTINCTION BETWEEN PROFESSIONAL AND HI-FI EQUIPMENT

In most applications, a variety of auxiliary equipment will be connected to the P2050, including: mixers, tape machines, compressors, graphic equalizers, echo, time delay, and reverb units, and just about any other audio electronics imaginable. Regardless of the function of auxiliary equipment, it will undoubtedly fall into one of two general categories, professional type or hi-fi type. The following criteria place most "semi-pro" equipment in the hi-fi classification.

The distinction between professional and hi-fi equipment is important primarily because it affects the way it will be used with the P2050. Brand name, size, panel colors, durability and subtleties in function are *not* the significant differences. What matters is that professional equipment and hi-fi equipment usually operate at different input and output levels, and require different source and load impedances to function properly. The P2050 is designed to function well with other professional equipment, although it has high enough input impedance and sensitivity to yield excellent results with hi-fi type equipment if a few precautions are observed. These precautions are outlined in the Installation section of the manual. The following paragraphs explain how the specific requirements differ for professional and hi-fi (or semi-pro) equipment.

IMPEDANCE

The inputs of a piece of professional audio equipment are usually designed to be driven from a low impedance source, nominally 150 to 600 ohms, and its outputs will drive low impedance loads (600 ohm or higher). Power amplifier *outputs* are not considered in this discussion. Professional input and output circuits may be unbalanced, but they are often transformer isolated (balanced or floating), and use dual conductor shielded cables, with 3-pin XLR type connectors or Tip/Ring/Sleeve phone plugs.

The P2050's inputs are unbalanced due to cost and adaptability factors. Internally balancing the P2050's inputs would require two matched input transformers with heavy shielding to avoid hum pickup from the P2050's power transformer. Induced hum in low level circuits, especially in low level transformers, can be a problem with any power amplifier or other high current device, such as a DC power supply. High quality external transformers with less shielding can achieve the same results with a substantial cost savings. In addition, the user can choose the optimum impedance ratio for a given situation, increasing the P2050's adaptability. Either the "matching transformer box" or "step up transformer box" described on Pages SIX 3, and SIX 4 are suitable, so long as they are kept several inches away from the P2050.

Hi-fi and creative audio equipment generally is designed to be driven from a 5,000-ohm or lower impedance source, and its output will drive 10,000-ohm or higher impedance loads. Hi-fi input and output circuits are usually unbalanced, and use single conductor shielded cables with 2-conductor connectors, either standard phone plugs or phono plugs, also called RCA or pin plugs.

Occasionally, the inputs of a piece of hi-fi or semi-pro equipment are professional XLR connectors which have been converted to a 2-wire, unbalanced circuit by internally connecting either pin 2 or pin 3 to pin 1.

The nature of unbalanced, balanced, and floating circuitry is discussed further in the Appendix of this manual. For the purpose of this discussion, the most significant point is that an unbalanced circuit is somewhat more susceptible to hum and noise, especially if there is any irregularity in the grounding system.

NOTE: THERE IS NO CORRELATION BETWEEN "BALANCED" OR "FLOATING" AND CIRCUIT IMPEDANCE.

Low impedance and high impedance are relative terms. A 150- to 250-ohm microphone is considered low impedance, whereas a 10,000-ohm mic is considered high impedance. A 600-ohm line is considered low impedance, whereas 10,000-ohm, 50,000-ohm or 250,000-ohm lines are all considered high impedance. Sometimes, mics and lines with an impedance of 600 ohms to about 2000 ohms are considered "medium" impedance.

NOTE: THE IMPEDANCE OF A CIRCUIT SAYS NOTHING ABOUT ITS LEVEL.

While the exact transition between low and high impedance is not clearly defined, the distinction is still important, primarily because the output impedance of a source determines the length of cable that can be connected between it and a load before a serious loss of high frequencies occurs. The losses occur because all cables have some capacitance between their conductors, especially shielded cables. Some guitar coil cords may measure as high as 1000 picofarads total capacitance! The source impedance, such as a high impedance mixer output, and the capacitance of a cable form a type of low-pass filter, a filter that attenuates high frequencies. This filtering effect can be reduced by using low capacitance cable, by shortening the length of the cable, by using a low impedance source or by some combination of these methods.

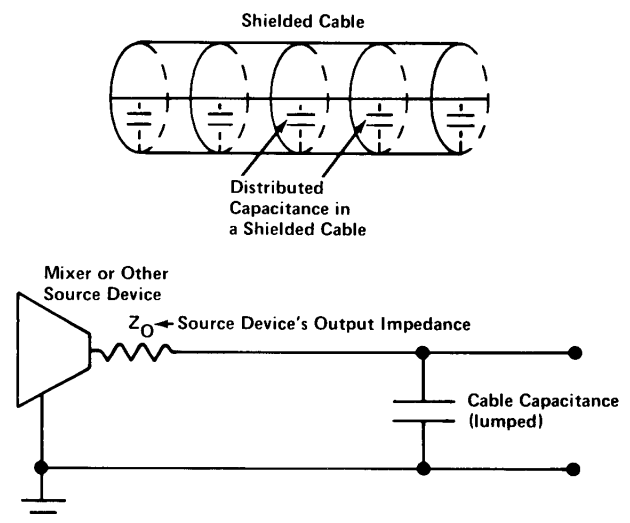

Fig. 25 — The Source's Output Impedance and the Cable Capacitance act as an "RC Lowpass" Filter which Attenuates High Frequencies.

FIVE2

Cables from high impedance sources (5000 ohms and up), should not be any longer than 25', even if low capacitance cable is used; shorten the cables if the impedance is higher. For low impedance sources of 600 ohms or less, cable lengths to 100' are usable. For very low impedance sources of 50 ohms or less, cable lengths of up to 1000' are possible with minimal loss. However, the frequency response of the source, the desired frequency response of the system, and the amount of capacitance and resistance in the cable all play a role in any potential high frequency losses. Thus, these values are meant as guide lines, and should not be considered fixed rules.

For short runs and in smaller systems with fewer components, the performance of an unbalanced circuit may be adequate. In a long cable run, a balanced or floating circuit tends to reject hum and noise pickup better than an unbalanced circuit, and in complex systems with several components separated by some distance and running on different AC outlets, balanced or floating circuits make proper grounding much easier.

In any given situation, the decision to use a hi-fi device or a professional one should be based on the specifications of the inputs and outputs of that device and on the requirements of the application. Here, reliability and serviceability can be important factors.

OPERATING LEVELS

Nominal professional line level is usually +4dBm or +8dBm; that is, the *average* program level is approximately 1.23V rms (+4dBm), or 1.95V rms (+8dBm) terminated by a 600-ohm line. The peak level may extend to about +24dBm (12.3V rms). The line input (high level input) of professional audio equipment is designed to accept levels on this order of magnitude without overdrive (clipping); most professional amplifiers can be driven to full output by nominal +4dBm input (source) levels, although a few units require +8dBm (1.95V rms) at their input to yield full output. See the discussion of "Gain Overlap" on Page FIVE 4.

Hi-fi type equipment usually operates at considerably lower line levels than professional equipment, often at -16dB (0.123 volts) to -10dB (0.245 volts) nominal level. Notice we use the expression "dB," not "dBm." This is because "dBm" denotes a *power level* relative to 1mW, or 0.775V rms across a 600-ohm impedance, whereas "dB" denotes a *voltage level* (as defined in this manual) relative to 0.775 rms. This is a subtle distinction, and is explained in greater detail in the Appendix on Page EIGHT 1, and on Page THREE 1 of the specifications.

The nominal -16dB (0.123 volts) level of hi-fi equipment is equal to 123mV rms (123 one-thousandths of a volt) across a 10,000-ohm or higher impedance line. Peak program levels may reach or slightly exceed +4dB (1.23V rms across a high impedance line). Note that a hi-fi unit capable of +4dB (1.23 volts) *maximum* output into a high impedance, does not possess adequate drive for 600-ohm circuits with *nominal* +4dBm level requirements. Thus, *hi-fi equipment is usually incapable of driving professional equipment to its full rated output, at least not without first reaching a high level of distortion.* Moreover, when the output of hi-fi equipment, which is almost always meant to be operated into a high impedance, is connected directly to the low impedance input of professional equipment, the hi-fi unit "sees" a partial short circuit. Depending on the circuitry, this may overload the hi-fi output, or it may simply drop the output level by a few dB. The P2050's input

sensitivity and input impedance are high enough to allow its use with most hi-fi or semi-pro equipment. However, it is a good idea to check the specifications for each situation. The point of this discussion is that impedance and level are extremely important considerations when connecting audio equipment.

DYNAMIC RANGE

Every sound system has an inherent *noise floor* which is the residual electronic noise in the system equipment or the acoustic noise in the room. The effective *dynamic range* of a system is equal to the difference between the peak output level of the system and its noise floor.

120dB SPL is the threshold of pain, and 30dB SPL is the quietest environment one is likely to encounter outside of an anechoic chamber. A concert with sound levels ranging from 30dB SPL to 120dB SPL has a 90dB dynamic range. The electrical signal level in the sound system, given in dB of voltage, is proportional to the original sound pressure level, given in dB SPL, at the microphone. Thus, when the program sound levels reach 120dB SPL, maximum electrical levels at the mixer's output might reach +24dB (12.3 volts), and maximum power levels at the P2050's output might reach 45 watts into an 8-ohm load. Similarly, where sound levels drop to 30dB SPL, minimum electrical levels will drop to -66dB (0.388 milli-volts) and power levels will drop to 45 nano-watts (45 billionths of a watt). These levels are not uncommon. The program still has an electrical dynamic range of 90dB: +24dB - (-66dB) = 90dB. This dB to dB correspondence is maintained throughout the sound system, from the original source at the microphone, through the electrical portion of the sound system, to the speaker system output. A similar correspondence holds for any other type of sound system, a recording studio system, disco system or a broadcast system.

Generally, the average electrical line level in the above sound system is +4dB (1.23 volts) corresponding to an average sound level of 100dB SPL. This average level is usually called the *nominal* program level. The difference between the nominal and the highest (peak) levels in a program is the *headroom*. In the above example, the headroom is 120dB SPL - 100dB SPL = 20dB (not 20dB SPL). Similarly, the electrical headroom is +24dB - (+4dB) = 20dB. This corresponds to a power headroom which is also 20dB.

In the above example, if the system had an electronic noise floor of -56dB (1.23 millivolts), and a peak output level of +18dB (6.16 volts), its dynamic range would only be 74dB. If the original program had a dynamic range of 90dB, then 16dB of the program would be lost in the sound system. There may be extreme clipping of program peaks, some of the low levels may be buried in the noise, or some of the program may be lost in both ways. Thus, it is extremely important to use wide dynamic range equipment, like the P2050 and Yamaha PM-Mixers, in a professional sound reinforcement system.

In the special case of a tape recorder, where the dynamic range is limited by the noise floor and distortion levels of the tape itself, one way to avoid these program losses due to clipping and noise is to "compress" the program's dynamic range (see Page SEVEN 3). A better way is to apply special "noise reduction" equipment which allows the original program dynamics to be maintained throughout the recording and playback process. This improvement in the dynamic range of recorded material again demands wide dynamic range from every piece of equipment in the recording/play-

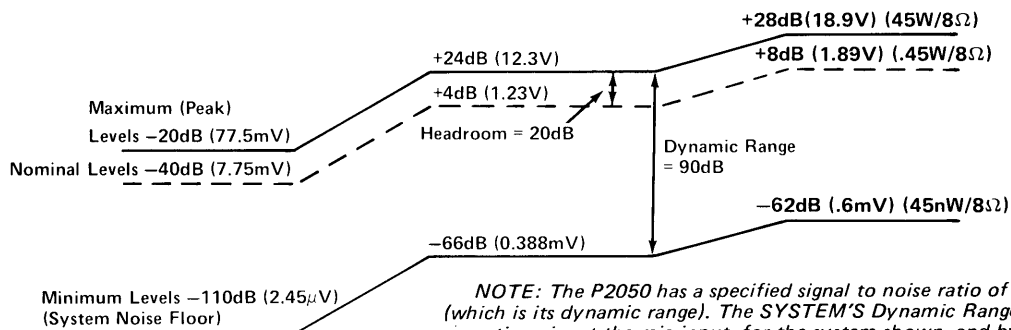
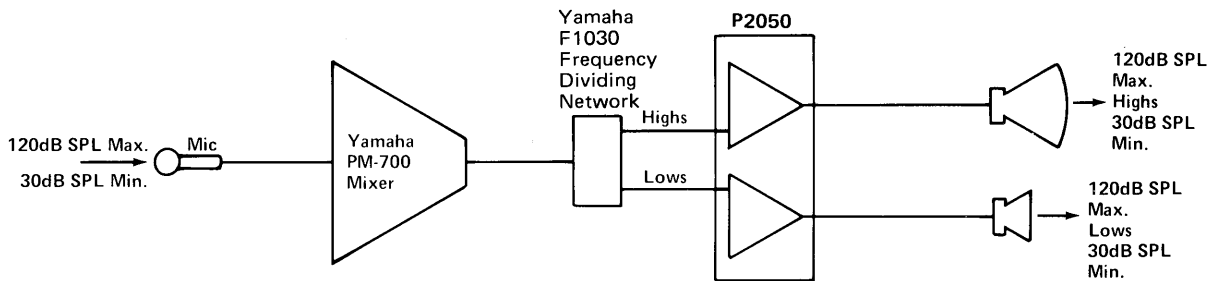
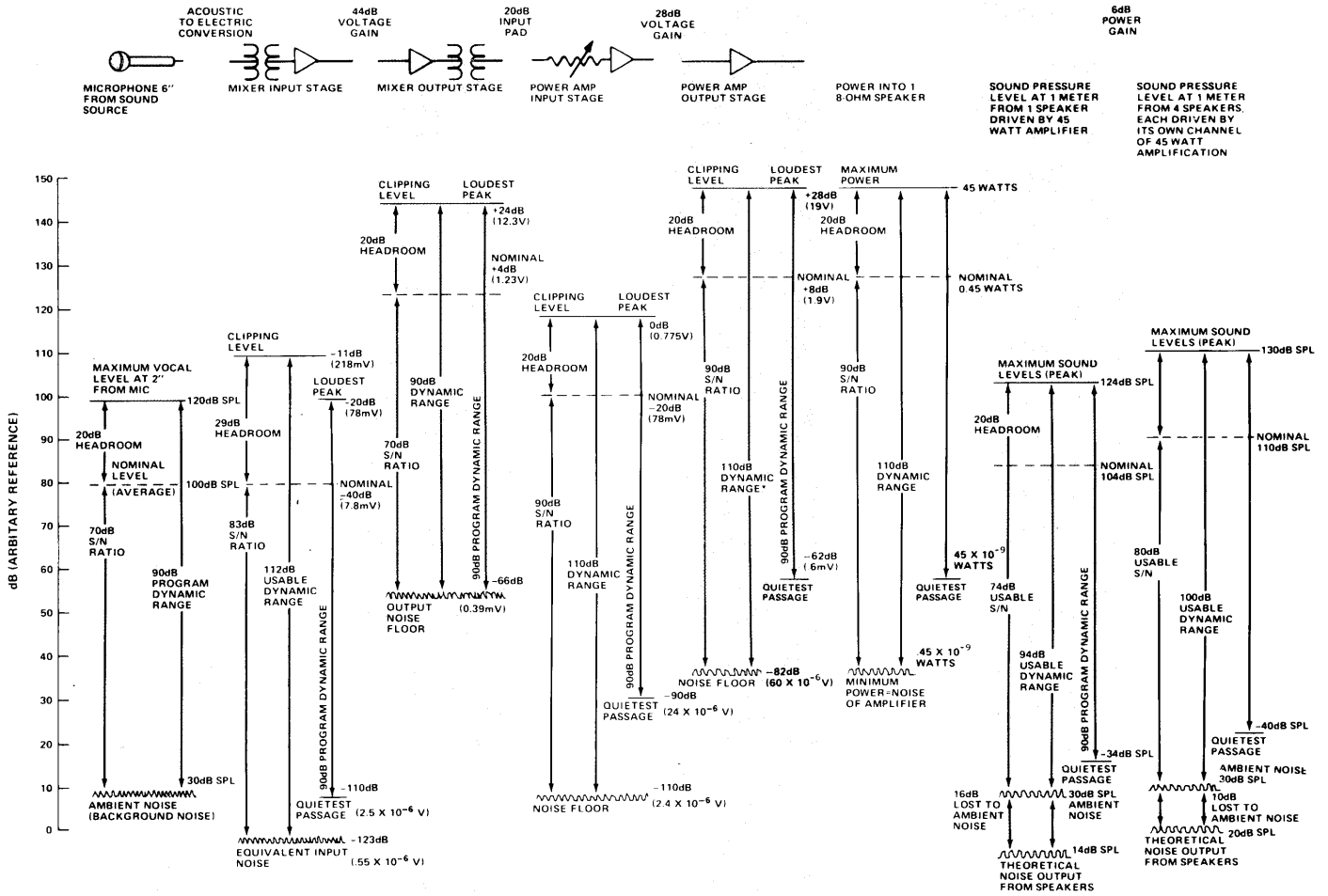

NOTE: The P2050 has a specified signal to noise ratio of 110dB (which is its dynamic range). The SYSTEM'S Dynamic Range is limited by acoustic noise at the mic input, for the system shown, and by the maximum dynamic range of the PM-700 Mixer (93dB), a very respectable figure for a high gain device.

Fig. 26 – Dynamic Range in an Audio System

back chain, including the power amplifier.

The P2050 is designed for these wide dynamic range applications. It has exceptionally low noise figures, and high headroom capabilities (high power output). In addition, its operating levels and impedances correspond with professional requirements.

GAIN OVERLAP AND HEADROOM

Yamaha PM-Mixers have +24dB (12.3 volts) maximum output levels. This high output level is advantageous in many situations. One reason is that it assures adequate headroom for driving the input of *any* professional device. High headroom is also important for a mixer that feeds a professional tape recorder, and in a concert sound reinforcement system.

Occasionally a "passive" device (no transistors or tubes) is inserted between the mixer and the power amplifier in a sound reinforcement system, or in a studio monitoring system. Examples of passive devices are passive graphic equalizers, passive low level cross-overs (frequency dividing networks), pads and resistive isolation networks. Passive devices always attenuate the signal level somewhat. For example, a passive low level crossover, when properly terminated, creates a 6dB loss between the mixer and the power amplifier. Passive graphic equalizers can create more than 6dB loss at some frequencies. Because a mixer with +24dB (12.3V) output drive has considerably more output level than is needed to drive the inputs of most amplifiers, passive devices may be used as desired. This extra output capability above that needed to drive the power amplifier is known as "gain overlap," and is one of the most important advantages of a Yamaha PM-Mixer over other mixers, especially non-professional mixers.

INPUT SENSITIVITY RATINGS

Some auxiliary devices have input sensitivities rated like this: "nominal input sensitivity: 0dB". Others may

be rated like this: "input sensitivity: 0dB for rated output". This latter type of rating is typical of many power amplifiers, including the P2050. The difference between these ratings is subtle, but very important. The first device, has a *nominal* input sensitivity of 0dB (0.775 volts), and may be capable of peak levels far above 0dB (0.775 volts); the actual headroom may be stated in another specification. The second device (the P2050 is an example), has a *peak* input sensitivity of 0dB (0.775 volts). A 0dB input signal to the P2050 drives it to full output. Thus, the user must carefully select the system's operating levels.

The gain overlap between maximum mixer output drive capability (typically +24dB) and power amp input sensitivity (0dB) lets the user choose a headroom figure for the P2050; this will be typically 10dB for speech or concert reinforcement, 15 to 20dB for high quality music reproduction or recording. The discussion on Page SIX 5 illustrates the headroom adjustment process.

PROFESSIONAL EQUIPMENT ADVANTAGES

The many advantages of professional equipment include: balanced lines for hum and noise rejection, low impedance circuits for long cable runs, high operating levels for maximum signal to noise ratio, high operating headroom for low distortion and low noise, and reliable XL-type connectors that are unlikely to be disconnected accidentally and that tend not to hum or pop when being attached. In addition, levels and impedances for professional equipment are relatively standardized, which, in many cases, eliminates the need for special adapters, pads, transformers, or preamplifiers. For these reasons, professional equipment, even though its initial cost may be higher, will almost always benefit the user on a long term cost/performance basis.

The P2050 user realizes all of these professional benefits. In addition the P2050 can be used with many hi-fi or semi-pro devices, such as guitar preamps, semi-pro or hi-fi tape machines.

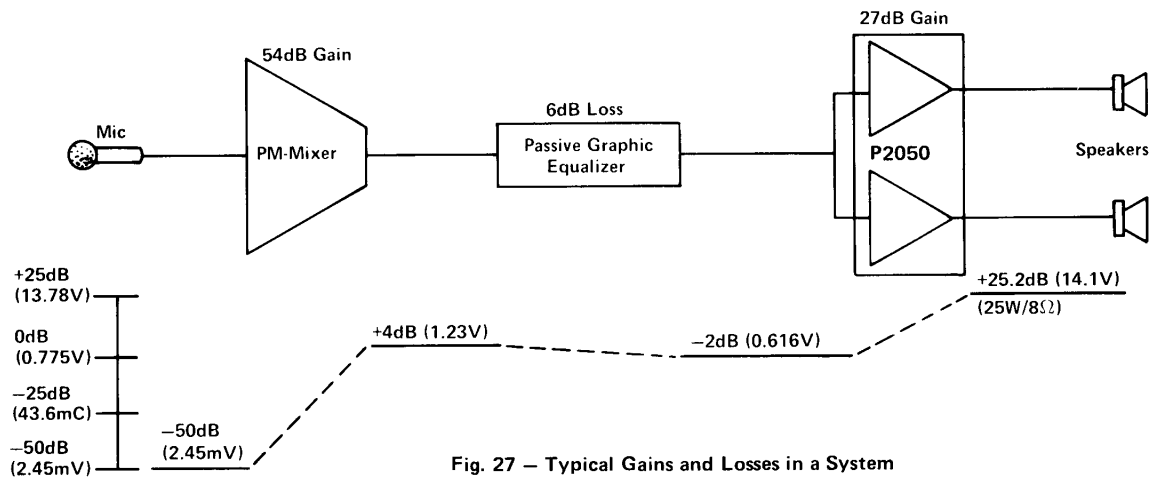

Fig. 27 — Typical Gains and Losses in a System

SECTION SIX¹

INSTALLATION AND DETAILED OPERATION

PHYSICAL MOUNTING

Shelf Mounting

The P2050 can be used on any surface, so long as there is adequate ventilation. Do not remove the P2050's feet, since this would prevent air flow below the amplifier.

Permanent Installation Rack Mounting

Mount the P2050 in any standard 19" electronic equipment rack as shown to the right. Leave adequate space between the P2050 and other devices in the rack for ventilation, and for expected cabling. Cooling fans may be required when the P2050 must produce extremely high average power output, or when it is located in a high temperature environment, such as a closed outdoor building in direct sunlight.

Rack Mounting for Portable Usage

Road cases must be durable enough to survive heavy cartage, and airline travel. Brace the rear of the P2050, and if the road case is small and ventilation is constricted, install cooling fans. One possible design is shown in Figure 28.

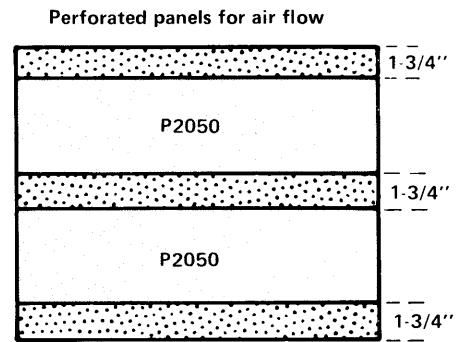
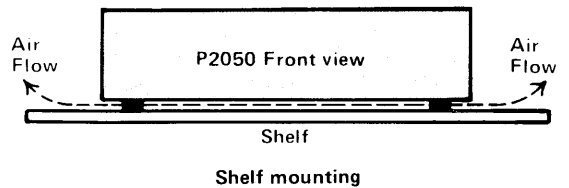

Permanent rack mounting

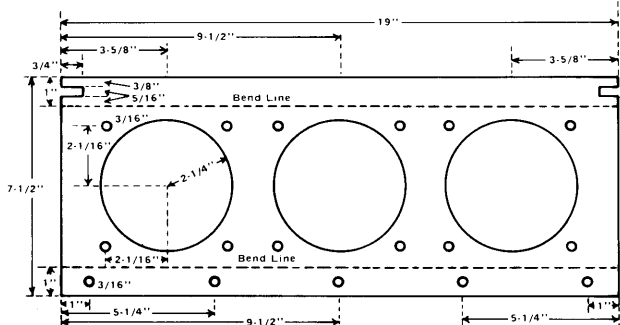

Front fan panel view before folding.

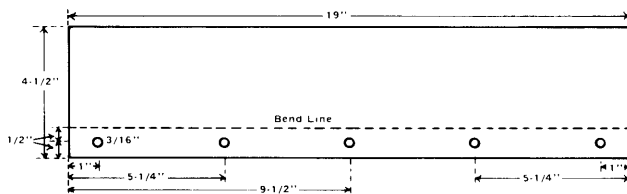

Rear fan air containment panel front view, before folding.

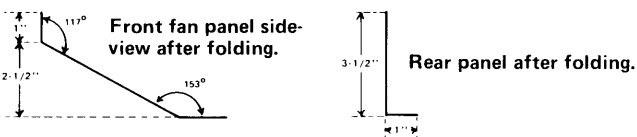

NOTE: Brace length assumes a front-back rack depth of 15\".

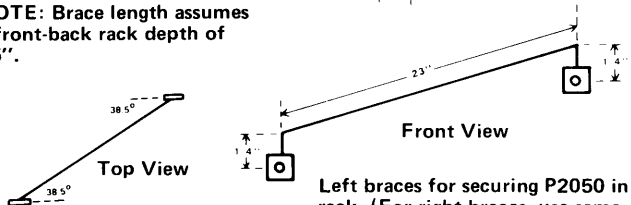

Left braces for securing P2050 in rack. (For right braces, use same measurements and flop.

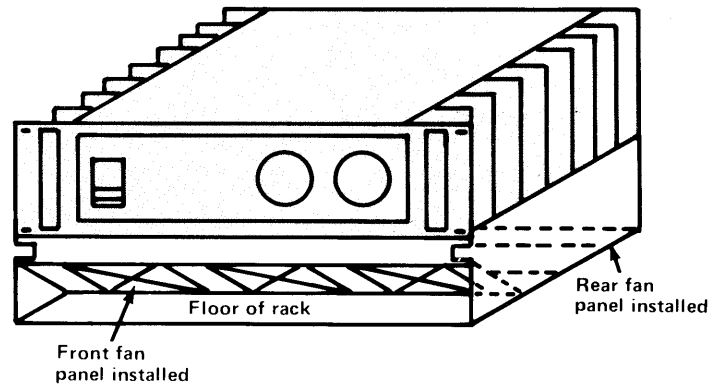
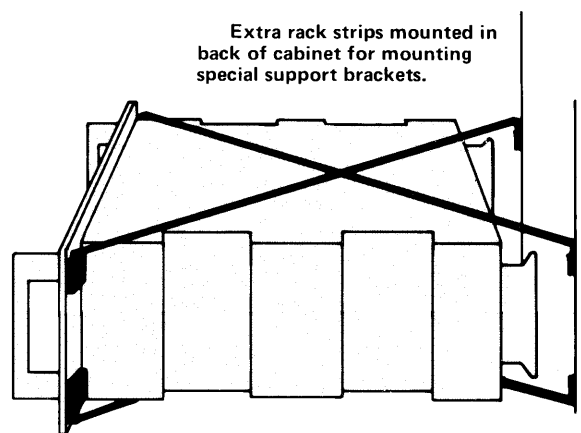

Fig. 28 — P2050 with Cooling Fans



P2050 mounted in rack showing support brackets made from bent pieces of 1/8" steel rod with nuts welded to their ends.

Regarding Input Impedance and Termination

There is sometimes a misunderstanding regarding the nature of matching or bridging inputs, the use of terminating resistors, and the relationship between actual input impedance and nominal source impedance. Most electronic outputs work well when "terminated" by an input having the same impedance or a higher actual impedance. Here, "terminated" means "connected to." Outputs are usually overloaded when terminated by an impedance that is lower than the source impedance. When the actual input impedance of the following device is nearly the same impedance as the source, it is known as a "matching" input. When the input of the following device is ten times the source impedance, or more, the input is considered to be a "bridging" input. There is hardly any loss of signal level when an input bridges the source device, but a matching input may cause a loss of 3 to 6dB in level. Such losses, however, are normal and usually present no problem.

It seldom is necessary to place a 600-ohm "terminating resistor" across any high impedance input. The P2050's input can be considered to be high impedance. In fact, most 600-ohm outputs operate normally when bridged by a high impedance; it is as though no load were connected to the source device.

The only instance where a terminating resistor may be required is when the manufacturer of the source device specifically states that a terminating resistor is necessary. In such cases, there is usually a special type of output transformer in the source device, or the device is constructed primarily of precision, passive components, such as a passive equalizer. In these cases, the terminating resistor assures optimum frequency response in that device. Input terminating resistors are not needed for the P2050 to operate correctly. If a 150 ohm or 600 ohm resistor is specified for the source device, it should be installed at the end of the cable nearest the P2050 in order to minimize possible hum, noise or signal losses in the cable.

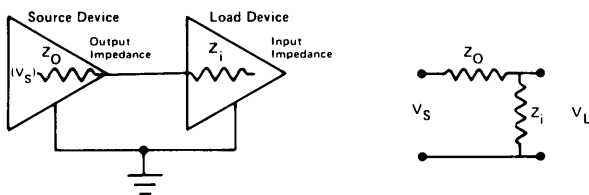

Fig. 29A - The Actual Voltage reaching the Load Device is given by the Formula: (also see Appendix)

$$V_L = V_S \left(\frac{Z_i}{Z_i + Z_O} \right)$$

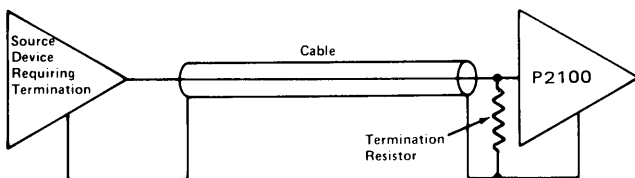

Fig. 29B - Where to Insert a Termination Resistor when one is required.

CABLING AND IMPEDANCE MATCHING

Attenuation Pads

A "pad" is a resistive network that lowers the level in an audio circuit. The most common professionally used pads are "T-pads" and "H-pads." T-pads unbalance true balanced lines and floating lines, but work well in unbalanced circuits. H-pads are best for balanced or floating lines, but should not be used in an unbalanced circuit since they will insert a resistance in the return lead (ground). For a discussion of other types of pads, refer to the AUDIO CYCLOPEDIA by Howard M. Tremain (Pub. Howard W. Sams).

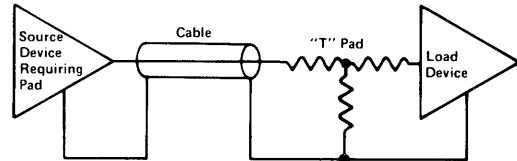

Fig. 30 - Where to Install a Pad when one is required.

Always install a T-pad near the input of the device it feeds, with as short a length of cable as possible on the low level side of the pad. This maintains a high signal level in the longer transmission cable, minimizing any induced hum and noise.

The low impedance pad values illustrated in Figure 31 are designed for 600-ohm lines. Commercially manufactured pads are available; consult your Yamaha dealer. When connected between a 600-ohm, or lower, source and a 600-ohm, or higher, termination, pad attenuation values will remain fairly accurate. For higher impedance circuits, resistor values must be changed. A 600-ohm pad inserted in a high impedance circuit may overload the device feeding the pad (the source device). Multiply the given values by the output impedance of the source device, and divide that answer by 600 to achieve the desired value. The high impedance values listed for the T-pads in Figure 31 are close approximations of average hi-fi pads, based on 10,000-ohm nominal impedances.

For low level circuits, use 1/4 watt resistors. For outputs with *continuous* sine wave levels above +24dBm,

dB Loss	R1 T (ohms)		R1 H (ohms)		R2	
0.5	300	16	150	8.2	180k	10k
1.0	560	33	300	18	82k	5.1k
2.0	1100	68	560	33	43k	2.7k
3.0	1710	100	820	51	27k	1.6k
4.0	2200	130	1100	68	22k	1.2k
5.0	2700	160	1500	82	16k	1k
6.0	3300	200	1600	100	13k	820
7.0	3900	220	2000	110	11k	680
8.0	4300	270	2200	130	9100	560
9.0	4700	270	2400	150	8200	470
10	5100	300	2700	150	6800	430
12	6200	360	3000	180	5100	360
14	6800	390	3300	200	4300	240
16	7500	430	3600	220	3300	200
18	7500	470	3900	220	2700	150
20	8200	510	3900	240	2000	120
22	8200	510	4300	240	1500	91
24	9100	510	4300	270	1300	75
26	9100	560	4700	270	1000	62
28	9100	560	4700	270	820	47
30	9100	560	4700	270	620	36
32	9100	560	4700	300	510	30
34	10k	560	4700	300	390	22
36	10k	560	4700	300	330	18
38	10k	560	4700	300	240	15
40	10k	560	5100	300	200	12
50	10k	620	5100	300	62	3.6

Fig. 31 - Attenuation Pad Construction and Resistor Values for High Impedance (10K-ohm) and Low Impedance (600 ohm) [shaded area] circuits.

use 1/2 watt resistors; for *continuous* sine wave levels above +30dBm, use 1 watt, low inductance resistors. 10% tolerance is acceptable for most pads.

It is possible to construct a pad within an XLR connector, but the extremely tight fit can adversely affect reliability. The Switchcraft model S3FM is a tube with a male A3M (XLR) at one end, and a female A3F (XLR) at the other end. Pads using 1/4 watt resistors can be constructed inside this device. Cover the entire pad with insulation tubing before final assembly into the S3FM.

A "mini-box" fitted with male and female XLR connectors is an easy to build, rugged housing for a pad. Use stranded wire for best results.

Illustrated are three typical pad construction techniques. For most applications, it will be sufficient to construct only a few types of pads: 20dB, 24dB and 40dB pads cover almost any requirement. Consult Figures 30, 31 and 32 for schematic, construction and resistor value information.

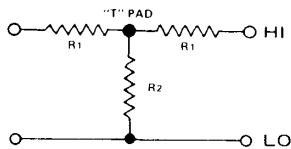
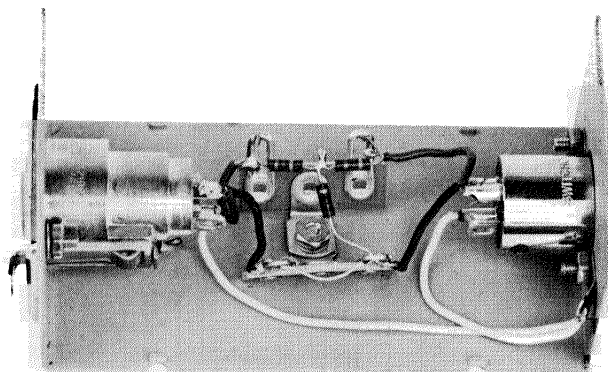

Fig. 32A — Pads Constructed in Mini-Boxes

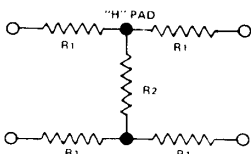
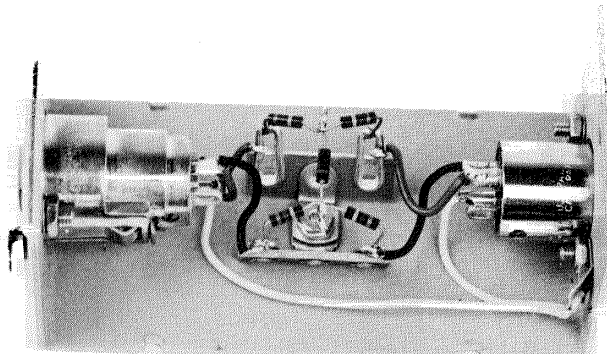

Fig. 32B — Pad Constructed in Switchcraft Model S3FM

Transformers

Audio transformers, as distinguished from power supply transformers, RF transformers or other transformers, are primarily used for ground isolation, impedance matching and level matching. The following paragraphs detail several applications of audio transformers at low signal levels. Speaker-level transformers are discussed on Page SEVEN 6; the Appendix gives further details on transformer operation.

Matching Transformer Box

Impedance matching transformers can be used to connect a high impedance source to a low impedance load, or vice-versa. See Page SIX 2 for a discussion of matching versus bridging inputs. The box shown below may be used to run a 600-ohm balanced or floating line to the P2050's input, or it may be used between any 600-ohm source and high impedance input. Use a transformer capable of handling expected nominal and peak operating levels.

The transformer should be mounted in a mini-box, wired to the XLR connectors with stranded wire, and connected to the auxiliary equipment with the appropriate audio cable. With suitable adapters, inline transformers, such as those manufactured by Shure Brothers, Sescam, and others may be used.

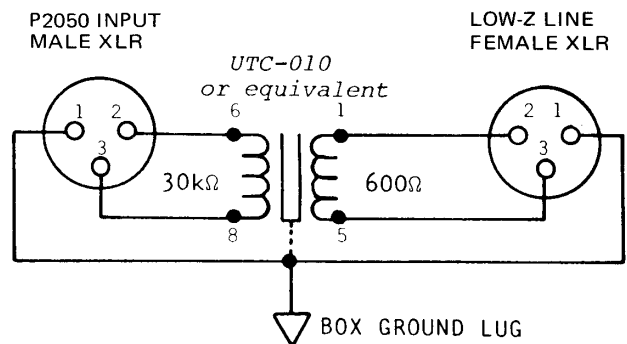
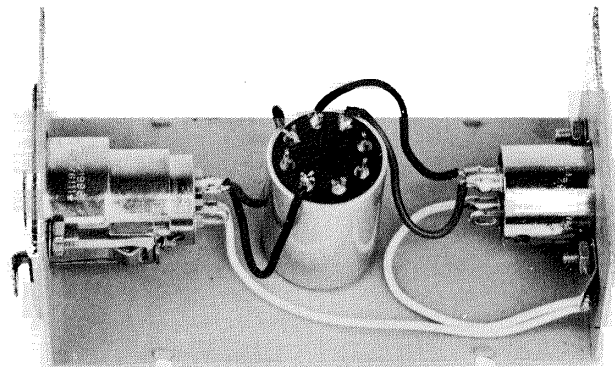

Fig. 33 — Matching Transformer Box

Step Up Transformer Box

The step up transformer box illustrated here is similar to a pair of matching transformer boxes. This configuration provides voltage step-up for optimum drive levels when connecting the output of a low impedance, low level source, such as the headphone output of a mixer, to the two inputs of the P2050. It has a stereo phone jack input; if the input source is monaural use a T.S. input jack, only one transformer, feed the P2050

SIX4

CH A input, and place the P2050 in Mono Mode. Alternately, the box may be built with separate T.S. phone jack inputs, or with XLR inputs. Two standard T.S. phone jacks are provided for connection to the "left" and "right" inputs of the P2050. Construct two cables from dual conductor, shielded cable and T.S. phone plugs to connect the transformer box output to the P2050's input. Locate the step up transformer box at least 5 feet from the P2050 to avoid hum pickup from the amplifier's power transformer. However, the cables from the transformer box to the amplifier should be no longer than 10 feet, since this is a high impedance circuit. Use low capacitance, coaxial, hi-fi type cable between the box and the amplifier. Since the inputs of the P2050 are unbalanced, connecting two cables to its input forms a short ground loop as shown in Figure 53 (see discussion of grounding on Page SIX 13). To keep hum pickup at a minimum, run the two cables close together; this minimizes the area, and therefore the hum, enclosed by the loop.

SIX 13). To keep hum pickup at a minimum, run the two cables close together; this minimizes the area, and therefore the hum, enclosed by the loop.

The two diagrams show circuits using a Triad A-65J transformer, and a UTC A-24 transformer. Similar 600 ohm to 15k-ohm transformers are acceptable. The 1/4 watt, 10%, 15k-ohm resistors are used to terminate the transformers for lower distortion and improved frequency response.

Bridging Transformer Box

When a single, low impedance, balanced source which must remain balanced feeds several P2050 inputs, the bridging transformer box should be used. While matching or step-up transformers like those just described would maintain a balanced feed, several such boxes could overload the source device. By using a transformer which has a high impedance primary and a high impedance

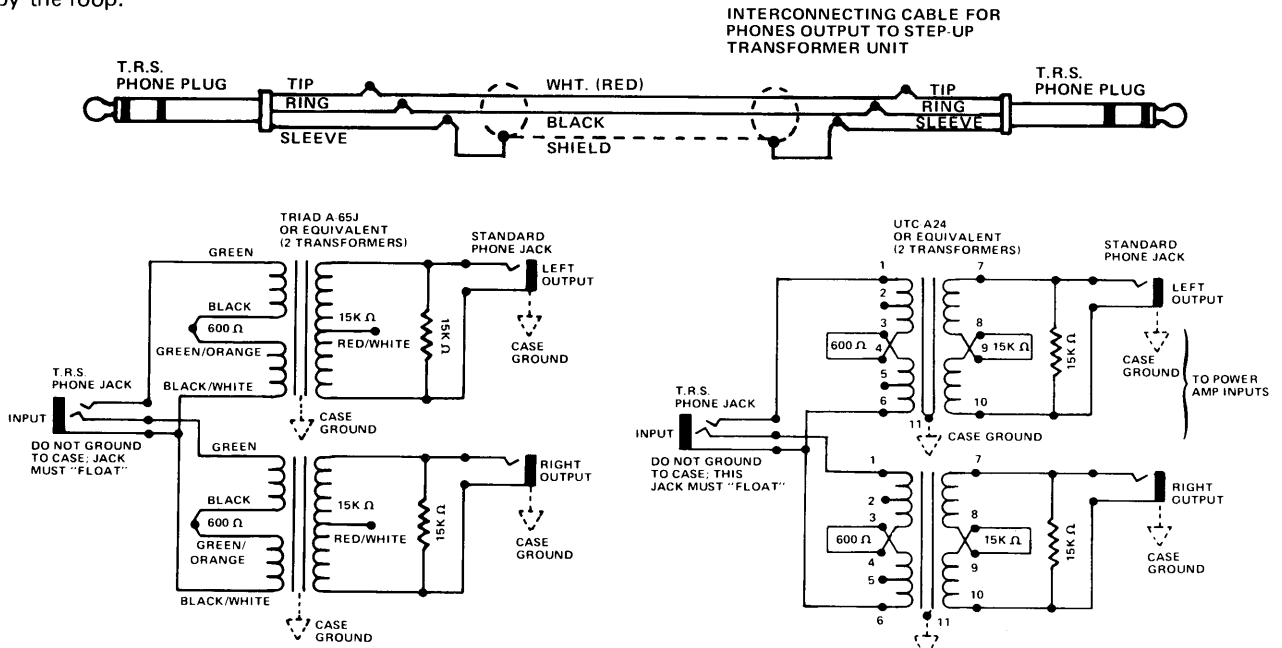

TRANSFORMER AVAILABILITY

The matching and step-up transformers mentioned in the preceding subsections are available from many electronic parts dealers. Yamaha does not endorse specific products by citing them herein; rather, these transformers are mentioned for convenience only. If you are unable to locate the transformers from your local electronic parts dealer, contact the manufacturer at the address shown below.

Sescom, Inc.
P. O. Box 590, Gardena, CA 90247
Phone (800) 421-1828 (213) 770-3510

Shure Brothers, Inc.
222 Hartrey Ave., Evanston, Illinois 60204
Phone (312) 328-9000 Cable: SHUREMICRO

Triad
305 N. Briant St., Huntington, Indiana 46750
Phone (219) 356-6500 TWX: 816-333-1532

UTC
150 Varick St., New York, NY 10013
Phone (212) 255-3500 TWX: 710-581-2722

A line of very high quality transformers, suitable for the most critical applications, is available directly from:

Jensen Transformer Company
1617 N. Fuller Ave., Hollywood, CA 90046
Phone (213) 876-0059

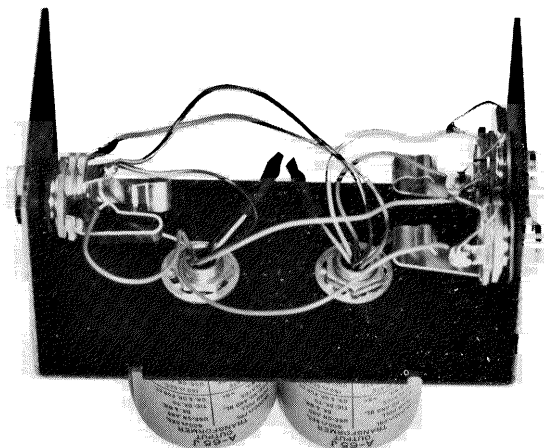

Fig. 34 — Step-Up Transformer Box

secondary, the source can feed several P2050 inputs without being overloaded. Use one box for each P2050 input, paralleling the primaries. The primaries are then fed from the single, balanced source, and the secondaries are connected to the P2050 inputs. Construct the box in a similar manner to the Step Up Transformer Box, or the Matching Transformer Box.

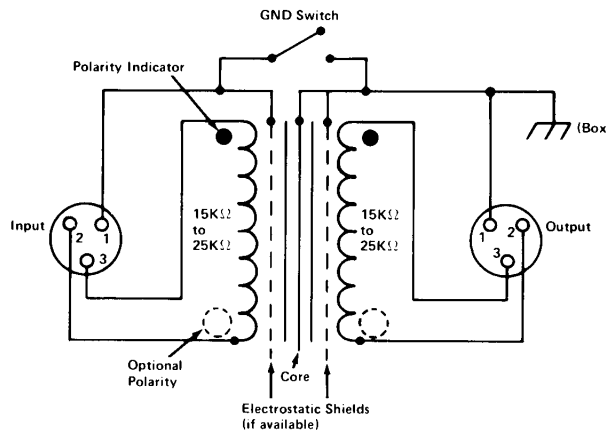

Fig. 35 – Bridging Transformer Box Schematic. Construction is similar to photos in Figures 33 or 34.

Input Impedance Matching for the P2050

While the input impedance of the P2050 varies somewhat with the setting of the input attenuator, for practical purposes, it is fixed at 25k-ohms. This means that any source device feeding the P2050 must be capable of driving a 25k-ohm load without overload, distortion, or failure. Any professional device, most semi-pro equipment, and most hi-fi devices meet this requirement.

When a single source device feeds the inputs of several P2050 amplifier sides, the effective load on the source is equal to the parallel combination of all the P2050 input impedances. To avoid overloading a high impedance source, use a resistor matching network, an impedance matching transformer, or insert a line amplifier with a lower output impedance between the source and the P2050's input.

Figure 36 is a voltage division diagram for the output impedance of a source device and the input impedances of several P2050's.

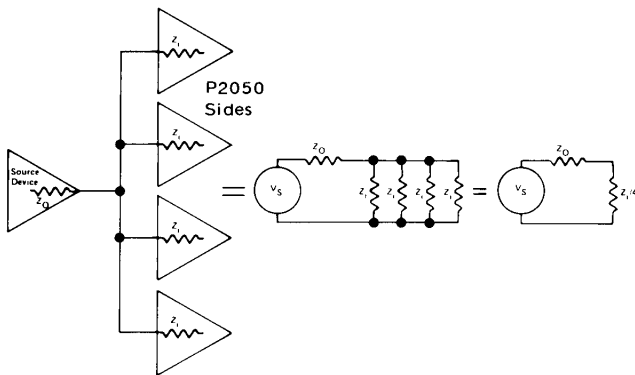

Fig. 36 – Voltage Division Diagrams

Level Matching and Headroom (also see Page FIVE 2)

Headroom is equal to the maximum undistorted signal level capability minus the nominal signal level at a given point. Noise floor is the average noise level at that same point in the audio system. The difference in level between the maximum undistorted output and the noise floor is the available dynamic range. Judicious setting of signal levels throughout the system can optimize the dynamic range of the system, thus minimizing the noise and maximizing the headroom.

First choose a headroom value. Bear in mind that music often has peaks that exceed 20dB above the nominal level. A 20dB headroom value represents a peak level that is one hundred times as powerful as the average program level. This means that for an 8-ohm load and a 20dB headroom value, even an amplifier as powerful as the P2050 has to operate at an average 0.45 watts output power. In some systems such as studio monitoring, fidelity and full dynamic range are of utmost importance. Since studio monitor speakers typically produce 100dB SPL at 4 feet with only 1 watt input, an average power as low as 0.05 watts may be adequate. In other situations, such as 70-volt background music systems, a 20dB headroom figure is undesirable and costly. For example, if 0.45 watts average power and 10dB headroom are acceptable, then only a 4.5 watt amplifier is needed. Thus, sacrificing 10dB headroom allows the 45 watt amplifier to drive ten times as many speakers.

For most sound reinforcement applications, especially with large numbers of amplifiers, economics play an important role, and a 10dB headroom value is usually adequate. For these applications, a limiter will help hold program peaks within the chosen headroom level, and thus avoid clipping problems. For the extreme situation where background music and paging must be heard over high continuous noise levels, yet dangerously high sound pressure levels must be avoided (i.e., in a factory), a headroom value of as low as 5 or 6dB is not unusual. With this low headroom value, and the extreme amount of compression and limiting necessary to achieve it without clipping distortion, the program may sound unnatural, but the message will get through.

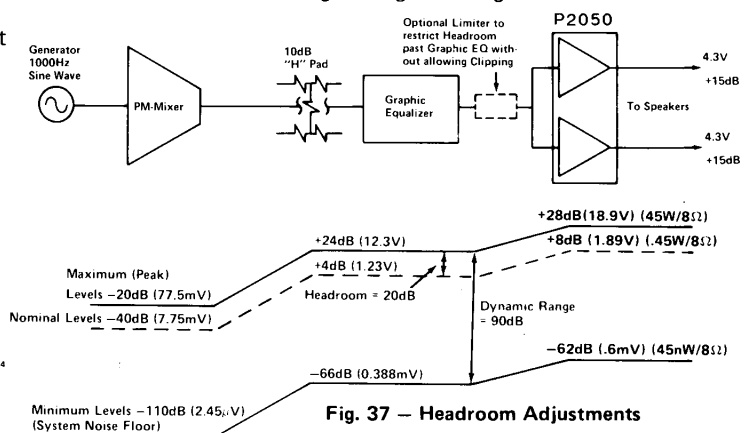

Fig. 37 – Headroom Adjustments

After choosing a headroom value, next adjust the incoming and outgoing signal levels at the various devices in the system to achieve that value. For the simple system in Figure 37, the adjustments for a 20dB headroom value would be made as follows:

- Initially, set the attenuators on the P2050 at maximum attenuation (full counterclockwise rotation). Feed a sine wave signal at 1000Hz to the mixer input at an expected average input level: approximately -50dB

SIX6

(2.45mV) for a microphone, +4dB (1.23 volts) for a line level signal. The exact voltage is not critical, and 1000Hz is a standard reference frequency, but any other appropriate frequency can be used.

2. Set the input channel level control on the mixer at its rated "nominal" setting, and adjust the master level control so that the output level is 20dB below the rated maximum output level for the mixer. For the Yamaha PM-180 Mixer used in the example, the maximum rated output level is +24dB (12.3 volts), so the output level should be adjusted to +4dB (1.23 volts), as indicated either on an external voltmeter, or on the mixer's VU meter (0VU).

3. Assume that the rated maximum input level for the graphic equalizer in the example is +14dB (3.88 volts). Subtracting +4dB from +14dB leaves only 10dB of headroom, so a 10dB resistive pad must be inserted between the mixer output and equalizer input. Now, the signal level at the input to the equalizer should be -6dB (388mV), which can be confirmed with a voltmeter.

4. Assume that the maximum rated output level of the equalizer in this example is +18dB (6.16 volts). Adjust the master level control on the equalizer so that the output level is 20dB below this rated maximum, or -2dB (616mV). Since the equalizer has no VU meter, you need an external voltmeter to confirm this level.

5. Finally, starting with the attenuators on the P2050 at maximum attenuation (full counterclockwise rotation), slowly rotate them clockwise, monitoring the output level with a voltmeter. When the voltmeter indicates 0.45 watts output from the P2050 (1.9 volts rms into an 8-ohm load), there is 20dB headroom left before clipping.

To operate this system, use only the controls on the mixer, and avoid levels that consistently peak the mixer's VU meter above the "zero" mark on its scale. Any adjustments of the other devices in the system will upset the headroom balance. However, the P2050's calibrated attenuators allow easy setups and quick changes, if you decide to change the headroom value. They also allow you to momentarily fade the entire program or a single channel and to later bring it back up to exactly the same level.

To use this technique with any system, first design the required speaker system, and calculate the number of power amplifiers needed to safely operate the speaker system with adequate headroom. Then, choose the mixer and other devices that feed the power amplifiers and set up the system according to the above instructions.

In some cases, it may be useful to set up different headroom values in different parts of a complex system. For example, background music and paging may need to be severely compressed in a noisy lobby area, but the same program material would sound more natural in less noisy office and auditorium areas of the same installation if the headroom value were increased. By placing a compressor/limiter in the circuit just before the P2050 that feeds the lobby areas, the headroom value can be lowered for that section only, without affecting other parts of the system.

Cabling the System

Audio circuits may be divided into the following classifications (by signal level):

1. Low level circuits carrying signals of -80dB (77.5 microvolts) to -20dB (77.5 millivolts), such as microphone lines.

2. Medium or line level circuits carrying signals of -20dB (77.5mV) to +24dB (12.3 volts), such as mixer outputs.

3. High level circuits carrying signals above +24dB (12.3 volts), such as speaker lines.

4. AC power circuits, including lighting circuits.

5. DC control (or supply) cables to relays, from batteries, etc.

Generally, each of these categories should be physically separated from the others to avoid crosstalk, oscillation, and noise spikes. One possible exception is that DC control or supply cables and line level signal cables can be routed together if the DC signal is adequately filtered. Figure 38 shows the undesirable results that can occur if line or speaker cables are placed near microphone cables. This situation occurs in concert sound when mixer outputs and mic inputs feed through the same "snake" cable.

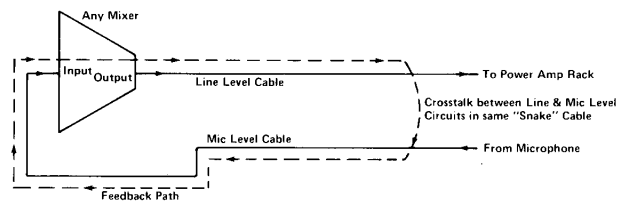

Fig. 38 - Example of Crosstalk

Figure 39 shows an equipment rack with a good cable layout. Note that the different categories of cable are carefully separated, and that where it is necessary to cross two categories, they cross perpendicular to each other. These suggestions apply to all types of systems, portable as well as permanent.

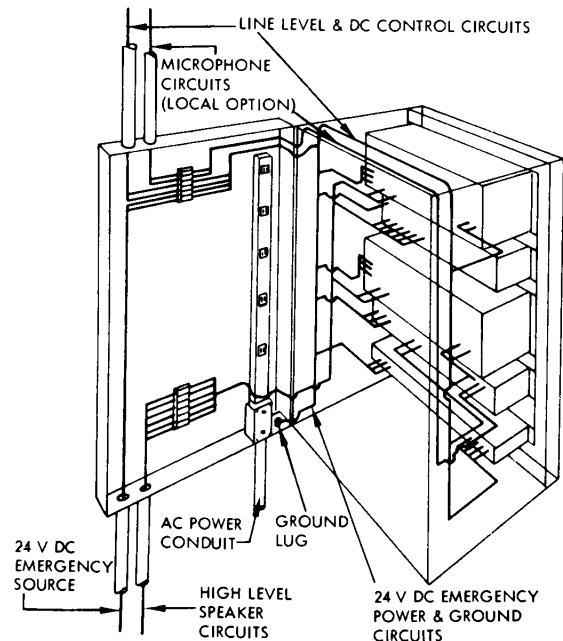

Fig. 39 - Cable Routing in Equipment Rack (Reprinted from Sound System Engineering by Don & Carolyn Davis published by H. W. Sams Co.)

Figure 40A shows the rear of a P2050 amplifier with its two inputs "chained" using a phone-to-phone cable. This is done for mono operation into two separate 8Ω speaker loads. "Mono" mode, shown in Figure 40B, differs in that a 16 Ω speaker load is connected across both "+" outputs, and only the CH A input is used.

For low and medium level balanced signal cables, use good quality twisted pair shielded cable. For portable use, a cable with rubberized insulation and braided shield, such as Belden No. 8413 or No. 8412, will handle easily, and survive road abuse. For permanent wiring, a vinyl insulated cable with a foil shield, such as Belden No. 8451, is easier to strip for terminations, and it pulls through conduits with less drag.

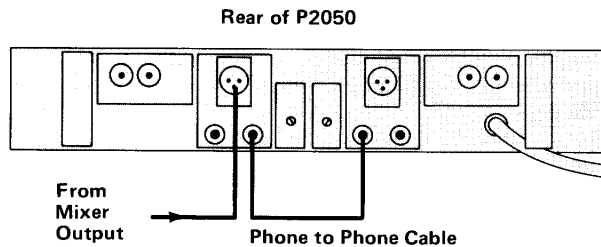

Fig. 40A — “Chaining” of Inputs for Mono Operation into Two 8Ω Loads.

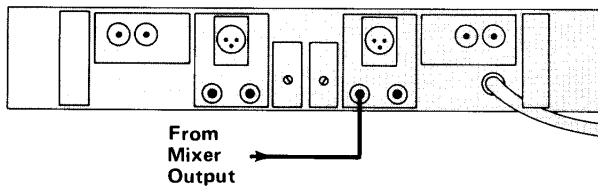

Fig. 40B — Input Connection for Mono Operation into One 16Ω Load. (Use CH A in only)

For unbalanced, signal level cables, use low capacitance shielded cable with a good quality, high-percentage density, shield. Again, rubberized types work best for portable use; vinyl types with foil shields are acceptable for permanent installations, although the foil shield may crack and split under the constant flexing of portable usage. Many single conductor shielded cables have an extremely fragile center conductor. To avoid this problem, use a higher quality dual conductor cable and ground one center conductor.

For high level speaker cables and DC control cables, use heavier gauge cable. The chart in Figure 41 shows the effects of different sized wire gauge on power losses in speaker cable. Except in extreme RF fields (radio

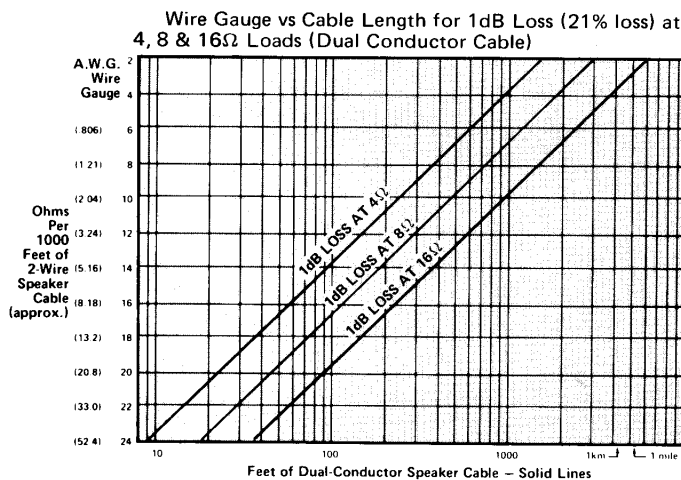

Fig. 41 — Effects of Different Sized Wire Gauge on Power Loss in Speaker Cables.

frequency interference), speaker and control cables will not need shields; when they do, use heavy-gauge shielded cable, or place the cables in steel or aluminum conduit.

Connectors

In many cases, connectors will be dictated by the types of equipment in the system. When you can make choices, the following guidelines may help.

Phone Connectors are an audio industry standard connector used for signal and speaker lines. T.S. (tip/sleeve) types, like those used as inputs on the P2050 are used for unbalanced signals; T.R.S. (tip/ring/sleeve) types are used for balanced signals, or for stereo unbalanced signals such as stereo headphones. Phone connectors are generally easy to wire, and the metal types provide good shielding. However, for high power applications, such as the output of the P2050, many phone plugs do not have rated current capacities high enough to avoid power loss. Also, some phone plugs have a brittle insulator between the tip and sleeve which can break if the connector is dropped, resulting in a tip to sleeve connection which is a direct speaker line short circuit. For this reason, phone jacks have not been used for the P2050 output. If you have another amplifier with a phone jack output, military grade phone connectors, while more expensive and somewhat harder to wire, are the best choice for avoiding these problems.

Phono Connectors are not usually considered professional, and are not included on the P2050. If phono connectors are part of a system, they should be the higher quality types with a separate cover, such as Switchcraft No. 3502.

XLR Connectors are another audio industry standard. They come in several configurations for different types of cabling, and can be used for either balanced or unbalanced connections. Three wire types, like those used as inputs on the P2050, are the most common. XLR connectors are generally very durable, and are well shielded. The three wire types have the added advantage that pin # 1 always connects before pins # 2 or # 3 so that the ground or shield wire connects before the signal carrying wires. This allows any static charges built up on the shields to equalize before the signals meet, reducing pops in the system.

Banana Jacks are common in the audio industry, and are a standard connector for test equipment. They do not provide any shield, and can be reversed in their socket. However, banana jacks like those used as output connectors on the P2050 have high current ratings, and are good speaker connectors, especially inside an equipment rack where occasional disconnections must be made.

Other Connectors are occasionally used in audio work. Standard, electrical twist-lock types have been used for speaker connections, although there is always the dangerous possibility of a mistaken connection to an AC power line. Multi-pin “snake” connectors are common for low level signals, but may be fragile and need careful handling. For permanent installations, and for permanent connections in portable equipment racks, crimp type spade lugs (as opposed to solder type) and terminal strips may actually provide the best type of connection since a properly crimped connection is more reliable, and lower impedance than a solder connection. A “hard wire” or direct connection is also reliable and low impedance if properly made.

CABLE AND CONNECTOR WIRING CONFIGURATIONS

The preparation of complete cables, with connectors properly installed, is the key to reliable and trouble-free operation of any sound system. For this reason, the following illustrations are included. Experienced audio technicians may wish to review these illustrations, even if they already know how to wire connectors. A few moments of extra care here can save hours of troubleshooting later on.

As a rule, the amount of insulation removed and the length of exposed cable should be minimized. This reduces the likelihood of short circuits and improves the ability of the clamp to grip the cable firmly. Enough heat should be used to obtain a free flow of solder, but allow leads to cool quickly after solder flows to avoid melting insulation. After each connector has been com-

pletely wired, the cable should be tested with an ohmmeter or a cable tester. Continuity between the various conductors and their associated connector pins must be established, and there should be infinite resistance (an open circuit) between all connector pins. In most cases, especially in portable installations, XLR connectors should not conduct at all between the shell and pin 1. This avoids grounding problems from inadvertent touching of the shell to other devices.

Cables to be connected to terminal strips should be prepared by stripping the ends and installing crimp-on or preferably, solder type lugs. If there is any chance the cable will be strained, use a cable that is constructed with internal strain relief cord, such as Belden No. 8412. Crimp a lug onto the cord, and secure the lug to an unused terminal. (The cord should be drawn slightly tighter than the wire leads in order to take the strain first.)

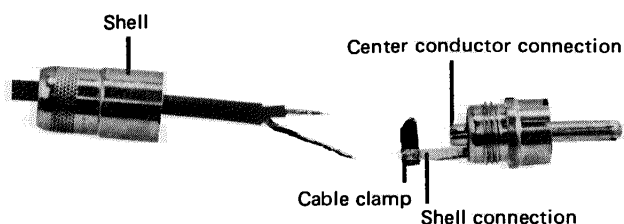

WIRING AN RCA-TYPE PIN PLUG*

Parts identification and cable preparation.

Strip approximately 1/2" of outer insulation. Unwrap or unbraid the shield and form a lead. Strip approximately 5/16" of insulation from the center conductor. Tin both leads.

Solder the shield to the outer surface of the shell connection, allowing enough free shield to wrap the cable around to the center of the connector. Cool the connection immediately with pliers.

Insert the center conductor in the hollow pin, and fill that end with solder. Cool the connection immediately with pliers. Clean any solder splashes and inspect for burned insulation. Pinch the clamp around the outer insulation with pliers, firmly, but not so tight as to cut the insulation.

Slide the shell forward and screw it tightly to the threaded plug.

**Switchcraft No. 3502 connector illustrated. Many large diameter cables are more easily wired to "simple" RCA type pin plugs without a shell (Switchcraft No. 3501M, or equivalent). The braid can then be soldered directly to the shell of the plug.*

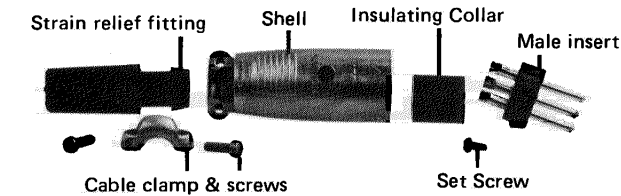

WIRING A MALE XLR CONNECTOR

Parts identification (as the connector is usually packaged).

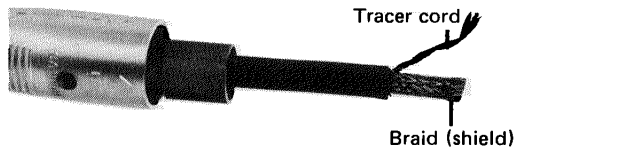

Insert strain relief in rear of shell. Then slip shell onto cable end, followed by insulating collar. Strip outer insulation 1/2". (No. 8412 cable illustrated here.)

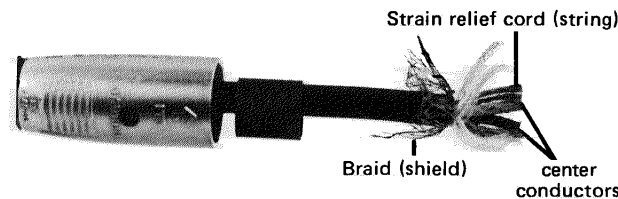

Cut tracer cord, unbraid shield, cut cotton strain relief cords.



Strip approximately 1/4" of insulation from center conductors, tin, and trim to approximately 1/8" exposed wire. Then twist shield, positioning it in the correct orientation to mate with the insert. After tinning the shield, cut it to the same length as the center conductors.

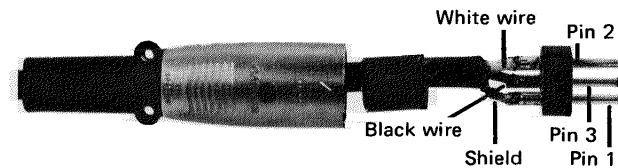

Solder the center conductors to their respective pins, using just enough solder to fill the end of the pins. Yamaha's wiring standard dictates that the black lead mates with pin 3 and the white (or red) with pin 2 (see footnote on page 10 of this section). Then solder the shield to pin 1. Clean any solder splashes and inspect for burned insulation.

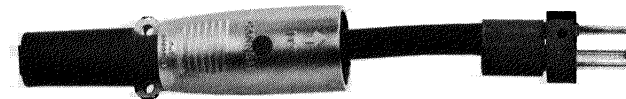

Slide the insulating collar forward, up to the flange of the male insert. The outer cable insulation must be flush with, or covered by the end of the insert. If any of the center conductors are visible, the cable clamp may not be able to firmly grip the cable. Then slide the collar back into the shell.

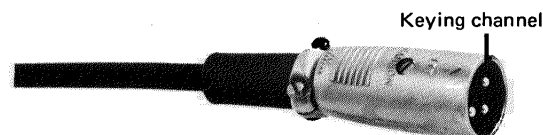

Slide the shell forward, orienting its internal keying channel with the raised lip (key) on the insert. Secure the insert in the shell with the set screw. Place the cable clamp over the rear of the shell, with careful attention to the clamp's orientation; a raised lip inside the clamp should be aligned immediately over a lip in the shell for thinner cable (No. 8451). The clamp should be turned around for heavier cable (No. 8412) to provide clearance. Insert the clamp screws and tighten fully.

SIX10

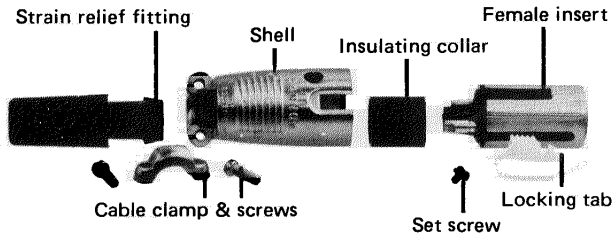

WIRING A FEMALE XLR CONNECTOR

Parts identification (as the connector is usually packaged).

Insert strain relief in rear of shell. Then slip shell onto cable end, followed by insulating collar. Strip outer insulation approximately 9/16". (No. 8451 cable illustrated here)

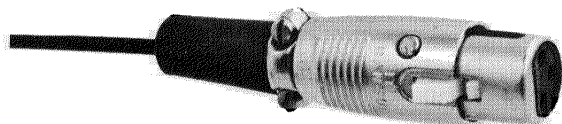
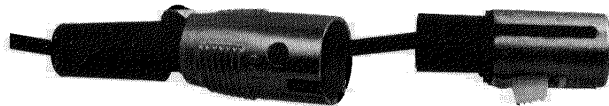

Pull off foil wrap. Strip approximately 5/16" of insulation from the center conductors, leaving approximately 1/4" of insulation between the bare wire and the outer insulation. Tin the center conductors, and trim so that about 1/8" bare wire remains. Then tin the shield conductor, orienting it with the center conductors so they are aligned with the proper pins of the insert. Cut the end of the shield so that it extends 1/16" beyond the center conductors.

Solder the center conductors to their respective pins, using just enough solder to fill the end of the pin. Yamaha's wiring standard dictates that the black lead mates with pin 3, the white (or red) lead with 2 (see footnote on page 10 of this section). Then solder the shield to pin 1. Clean off any solder splashes, and inspect for burned insulation. Insert the locking tab in the female insert, as illustrated, with small nib facing front of connector.

Slide insulating collar forward, up to rear edge of female insert. The outer insulation of the cable must be flush with, or covered by the end of the insert. If any of the center conductors are visible, the cable clamp may not be able to grip the cable firmly, and the connector leads will soon fatigue. Then slide the collar back into the shell.

Slide the shell forward, orienting the notch in the shell with the locking tab in the insert. Secure the insert in the shell with the set screw. Place the cable clamp over the rear of the shell, with careful attention to the clamp's orientation; a raised lip inside the clamp should be aligned immediately over a lip in the shell for thinner cables (No. 8451). For heavier cables (No. 8412), the clamp should be turned around to offset the lips and provide more clearance for the cable. Insert the clamp screws and tighten fully.

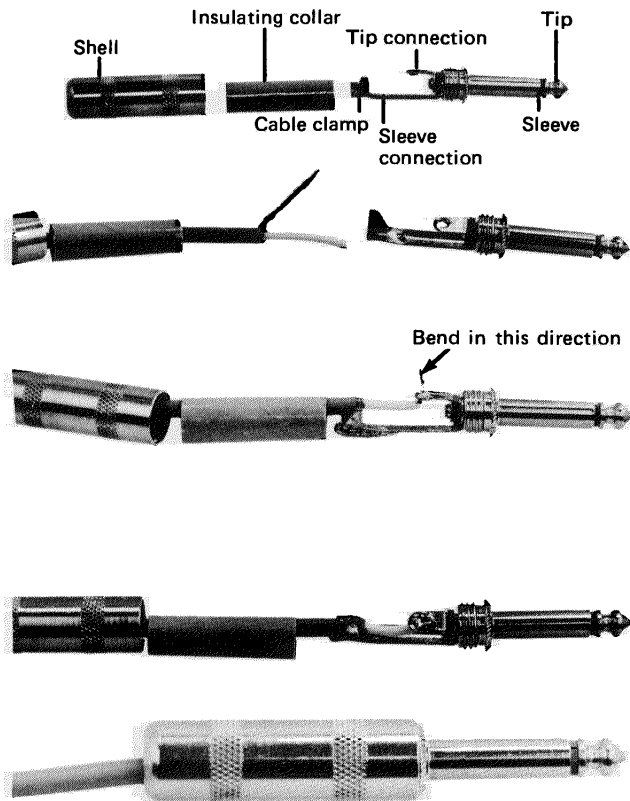

WIRING A STANDARD PHONE PLUG (2-conductor)

Parts identification.

Slide shell, then insulating collar over cable end. Strip outer insulation for length equal to length of sleeve connection. Unwrap or unbraid shield, twist to form lead.

Position outer insulation just ahead of cable clamp, strip center conductor from point just behind tip connection. Tin center conductor and shield. Bend shield as illustrated, solder to outer surface of sleeve connection. (Cool immediately with pliers.) Insert center conductor in tip connection, solder, cut end flush. Bend the end of the tip connector (slightly) toward the sleeve connection to help prevent the burr (from the cut wire) from cutting through the insulating collar.

Using pliers, bend cable clamp around outer insulation. Clamp should be firm, but not so tight as to cut insulation.

Slide insulating collar forward, until flush with rear of threads. Slide shell forward, screw tight to plug assembly.

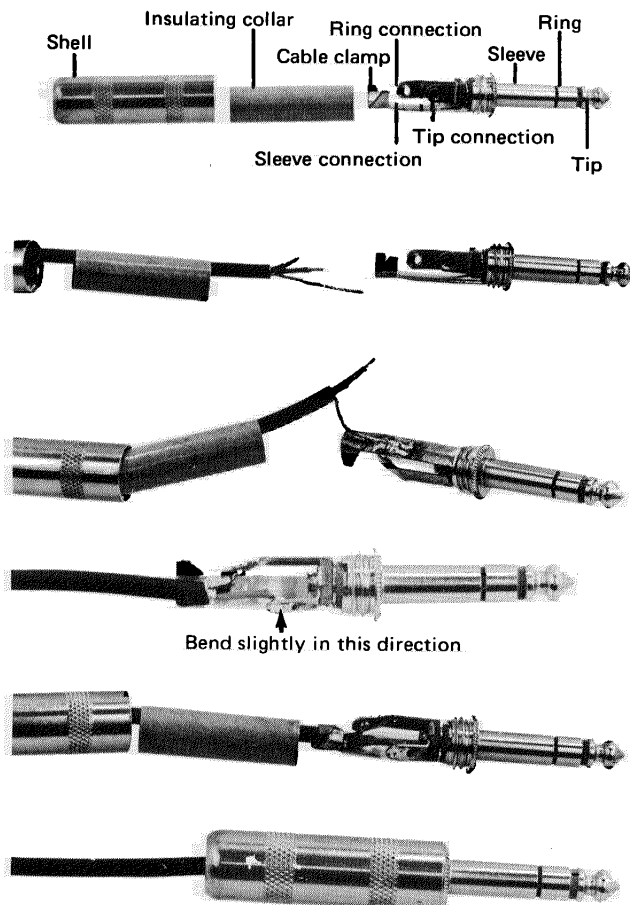

WIRING A TIP, RING & SLEEVE PHONE PLUG (3-conductor)

Parts identification.

Slide shell and insulating collar over cable end. Strip outer insulation for length equal to length of sleeve connection. Remove any tracer cords and strain relief cords. Form lead from shield. Hold cable with outer insulation just ahead of cable clamp, and strip the red (or white) conductor just behind the tip connection. Then strip the black conductor just behind the ring connection. Tin all leads, and cut the center conductors so approximately 1/8" of bare wire remains.

Solder the shield to the outer surface of the sleeve connection, allowing enough free shield to bend around to the other side of the cable clamp. Cool the connection immediately with pliers.

Insert the center conductor leads in their respective connection points, and solder in place. Trim the leads flush. Bend the end of the tip connection (slightly) toward the ring connection to help prevent the burr (from the cut wire) from cutting through the insulating collar.

Using pliers, bend the cable clamp around the outer insulation. The clamp should be firm, but not so tight as to cut the insulation.

Slide the insulating collar forward, until flush with rear of threads. Slide the shell forward, and screw tightly onto plug.

SIX12

Use of the Input Polarity Switch

The XLR input connectors on the P2050 are unbalanced. In one position, the switch beside the connectors attaches pin 2 to pin 1 (ground) leaving pin 3 "hot" conforming to US practice. In the other position, the switch attaches pin 3 to pin 1 (ground) leaving pin 2 "hot" conforming to DIN/JIS standard. If the source feeding the P2050's input is unbalanced, the switch must be properly set to avoid shorting out the source. If the source is balanced, the P2050's inputs will unbalance the source. In many situations, this is acceptable; however, the input polarity switch must still be set in the position corresponding to the "hot" pin of the balanced source. If the switch is set in the wrong position, the signal effectively will be 180 degrees out-of-phase at the P2050's output compared to the signal at the source (reversed polarity).

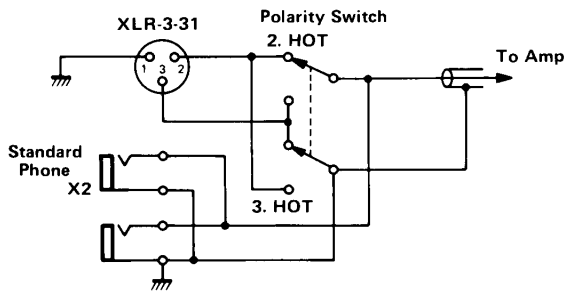

Fig. 42 - P2050 Input Circuit

Output Impedance Matching

Within its rated power and voltage limits, the P2050 acts very much like a perfect voltage source (see Appendix). Thus, as the impedance of the load goes down, the total power delivered by the P2050 goes up. Figure 4, Page FOUR 1 illustrates this action. Note that when the impedance of the load falls below 2.5 ohms, the P2050's protection circuitry begins to limit the total amount of power delivered.

For purposes of calculating the total load impedance that is presented to the P2050, assume that speaker impedances do not change with frequency. The Appendix shows various series and parallel combinations of speakers and the effective loads they present to the P2050. Formulas for the power delivered to each speaker in a parallel or series combination are included.

Note that a series connection of two speakers degrades the damping factor because each speaker looks back at the amplifier through the impedance of the other speaker (see Page FOUR 7). Thus the effective output impedance of the P2050 as seen by one speaker

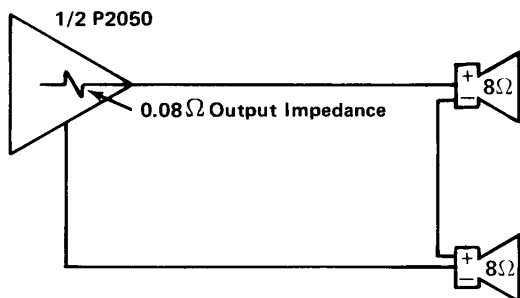

Fig. 43A - Speakers in Series

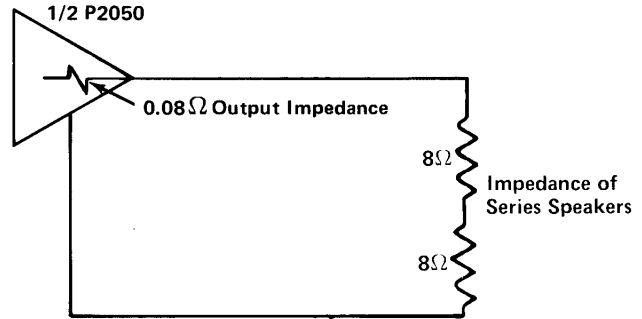

Fig. 43B - Equivalent Circuit: Speaker Impedances in Series

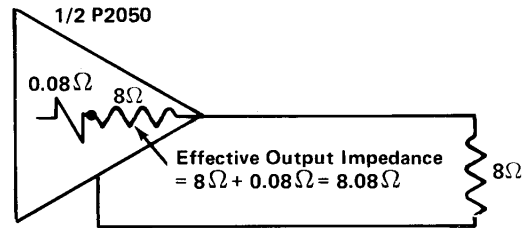

Fig. 43C - Circuit as Seen by One Speaker of Series Pair

is equal to the actual output impedance of the P2050 plus the impedance of the other speaker.

Also, the impedance of most speakers lowers with frequency, so that the effective load of two "8 ohm" speakers in parallel across the output of the P2050 may be as low as 2.5 to 3 ohms at certain frequencies. Thus, speaker loads much lower than 8 ohms nominal impedance could overload the amplifier, especially if the actual impedance drops far below the nominal impedance. Figure 44 shows the variation of impedance magnitude with frequency for one type of speaker system.

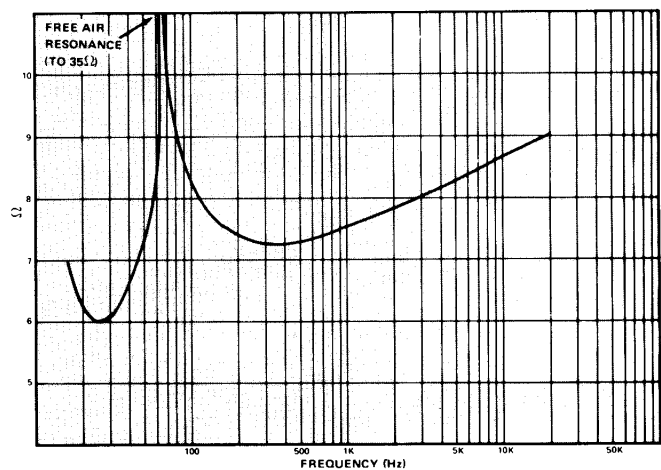

Fig. 44 - Free-Air Impedance of Typical "8Ω" Loudspeaker
NOTE: Impedance changes when loudspeaker is installed in a cabinet.

The impedance of constant-voltage speaker transformers, such as those used on "70-volt" and "25-volt" commercial sound systems, also falls with frequency. This effect is exaggerated in lower quality transformers. Note that a "perfect" transformer would not have any impedance of its own. If low efficiency transformers are used, the system will need more transformers and speakers to achieve the same SPL than if higher quality

transformers were used. Thus, "economy" transformers may actually cost more in the long run than higher quality professional types. The P2050 is not intended for use in 70 volt systems, but may be used in 25 volt systems. In such installations a capacitor in series with the output of the P2050 can limit the current at low frequencies (see Page SEVEN 6), and thereby avoid the possibility of constant protection circuitry operation, or damage to the transformers from excessive output power from the P2050.

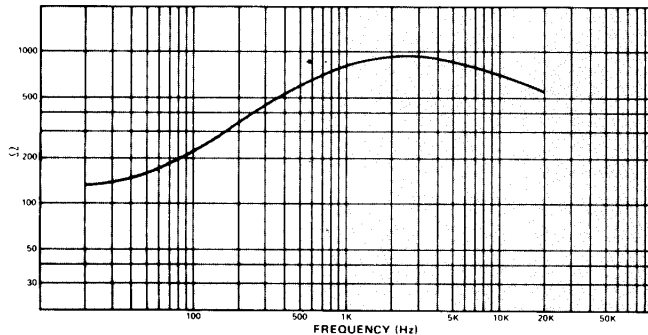

Fig. 45 — Impedance of Poor Quality 70-Volt Speaker Transformer (Connected to 8Ω Speaker, Tapped for "5 Watts," looking into Primary). 25-Volt Transformers Exhibit Similar Behavior.

ACTIONS OF THE P2050 PROTECTION CIRCUITS

Several of the P2050's features contribute to the protection of the amplifier and its loudspeaker load:

Fuse

The AC line fuse protects the P2050 from excessive AC line voltage and, in the unlikely event of an internal failure, the AC line fuse protects the amplifier from severe damage. Always replace a blown fuse with the same size and type. If the fuse blows consistently, the P2050 should be checked by a qualified technician.

Grounding

The third wire on the AC line cord is a ground wire. This wire connects the chassis of the P2050 to AC ground for safety. Do not defeat this safety feature unless other methods have been employed to ensure a good AC ground.

Thermal Protection

There is a thermal fuse, located inside the P2050's power transformer, that shuts down the AC power to the P2050 if the temperature of the transformer windings reaches 130° Centigrade. Special heat compensating circuits in the P2050 insure that the amplifier will perform properly within its operating temperature limits.

Overload Protection

The P2050's overload protection circuits limit the maximum power available to drive any load. The effect of these circuits is to smoothly limit the power to loads below 2.5 ohms. The overload protection circuit action is virtually inaudible, even when driving difficult, multi-speaker loads. Figure 4, Page FOUR 1 and Figure 15, Page FOUR 3 graph the power output of the P2050 for varying load impedances.

Transients and DC Protection

The P2050 displays virtually no turn-off transient, and the turn-on transient is minimal. A DC voltage at the input will not be amplified (Figure 20, Page FOUR 4), thus protecting speaker loads against damage from DC at the output of the P2050.

GROUNDING AND SHIELDING

Definitions

Ground: A general term, used in various ways throughout the audio industry. It can mean the same as "common," "earth," "chassis" or "return."

Earth: A connection made to the actual soil or dirt. Also a connection made to a cold water pipe or any other device that ultimately enters the soil, and that can provide a very low impedance path to the soil.

Common: The "return" wire of an audio pair; any point where several such return wires connect with each other. There can be "signal commons," "DC power supply commons" or "AC power supply common" (neutral). A common wire may or may not be connected to ground or earth. Similarly, the AC power supply ground may or may not be connected to the audio system common or to earth.

Shield: A metallic shell around a cable, amplifier, or other device that helps prevent the entrance of unwanted interference.

Grounding: The process of careful connection of common, shield, ground, and earth connections to avoid unwanted hum and noise.

Ground Loop: If a common or return signal can travel from one point to another via two or more paths, the resulting circular path is called a "ground loop."

Figure 46 shows two possible ground loops in an audio system.

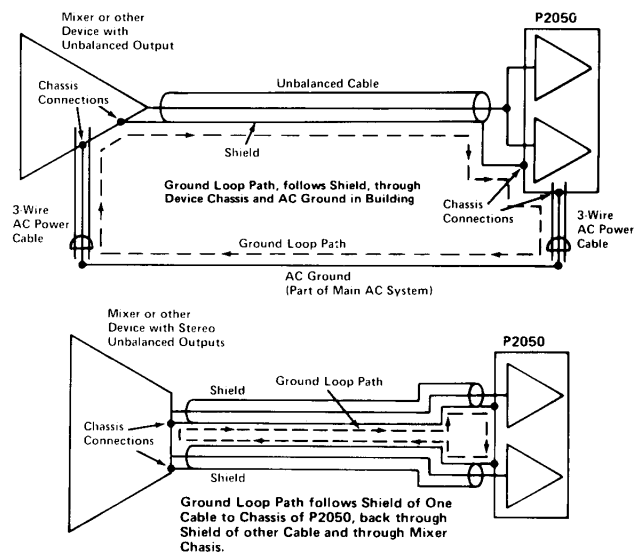

Fig. 46 — Two Possible Ground Loops in an Audio System

RFI: RFI (radio frequency interference) comes from any number of sources, including radio stations, CB radios, SCR (electronic) light dimmers, neon lights and others. RFI may show up in a sound system as a radio program, as a hum or buzz, or as other noise. RFI often enters a sound system at a low level preamplifier stage. Many RFI problems can be cured by careful grounding and shielding, and by the use of balanced, twisted pair cables.

EMI: EMI (electro-magnetic interference) typically comes from power transformers (either in a sound system or a building's electrical supply), motors, or cables carrying large amounts of current. EMI usually shows up in a sound system as a hum or buzz. Twisted

pair, balanced lines effectively reject most EMI. Whenever possible avoid placing sensitive equipment near motors or transformers, and use twisted pair balanced lines. Keep input transformers several inches away from the P2050's power transformer.

Careful grounding and shielding can minimize externally caused hum and noise. These techniques, in essence, are to use balanced lines, use shielded cables, and eliminate ground loops.

Use of Balanced Lines

Balanced lines are discussed in the Appendix. This paragraph summarizes their advantages over unbalanced lines for noise rejection. Balanced lines reject RF and electromagnetic interference by phase cancellation between the conductors; twisted conductors aid the rejection. Balanced lines help avoid grounding problems because the shield does not carry any signal current, as is explained further in following paragraphs. Also, any noise currents entering the shield cannot directly enter the signal path because the shield is not part of the signal path (in contrast to an unbalanced line, where the shield is the signal "return" wire).

Use of Shields

An effective shield also aids noise rejection. The shield effectiveness of many types of cable is specified in percentage of density. A close braided shield can be highly effective, but may be more expensive and is harder to work with than foil shields. Foil shields, in most cases, are more suitable for permanent cable connections since they are easier to prepare. Many guitar cables, especially the coil type, have poor shields and are the source of much of the hum common in guitar/amplifier systems. A poor quality cable may also exhibit "microphonics," a condition where movement of the cable can cause noise in the sound system.

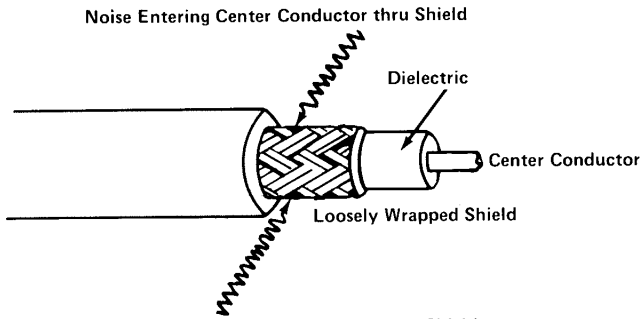

Fig. 47 – Poor Quality Shielded Cable

Metal equipment racks and metal electrical conduits are also effective shields against RF noise. However, few shields offer really effective protection against electromagnetic interference (EMI). Solid iron conduit and, possibly to a lesser extent, steel conduits and racks do offer some protection. Fortunately, however, most EMI can be avoided effectively by keeping sensitive wiring and equipment away from large power transformers, electric motors, etc., and by using balanced, twisted pair cabling whenever possible.

Ground loops are a common source of noise pickup. Figure 55 shows the way noise enters a system through a ground loop. One common source of ground loops in a sound system is the double grounding path between equipment caused by AC grounding the chassis of each piece of equipment, and then making a second ground connection between the two chassis via the signal cable

shield. Figure 46, Page SIX 13 shows this problem. Figure 49 shows a method of avoiding this type of ground loop in a system by using what is known as a "telescoping shield" connection where each piece of equipment is AC grounded for safety, but a ground loop is avoided by connecting the signal shield at one end of the cable only. Traditionally, the shield is connected at the "far" end of the cable, so that shield currents "drain" in the same direction as the signals flow. Figure 51 shows a similar connection using unbalanced lines. The AC grounds on each device have been "lifted" so that the only ground connection between two pieces of equipment is the shield of the signal cable. Since, in an unbalanced cable, the shield carries signal current, it cannot be disconnected. Moreover, in this type of unbalanced grounding scheme, if the shield becomes disconnected inadvertently at some point along the signal path, some pieces of equipment will not have an AC ground, so safety is compromised.

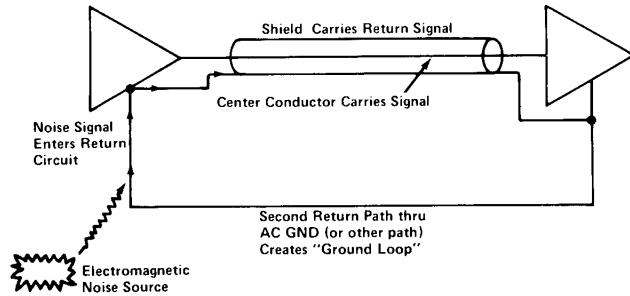

Fig. 48 – Noise Entering System through Ground Loop

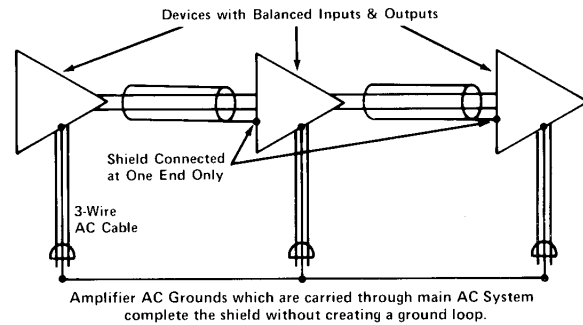

Fig. 49 – Telescoping Shield

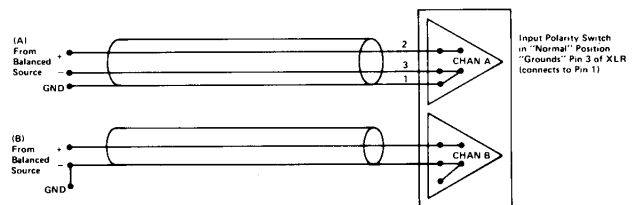

Fig. 50 – Feeding the Input of the P2050 from a Balanced Source without a Balancing (Bridging or Isolation) Transformer. Unbalancing the line at the P2050's input (CHAN A Diagram) will usually result in lower hum levels than unbalancing the line at the source (CHAN B Diagram).

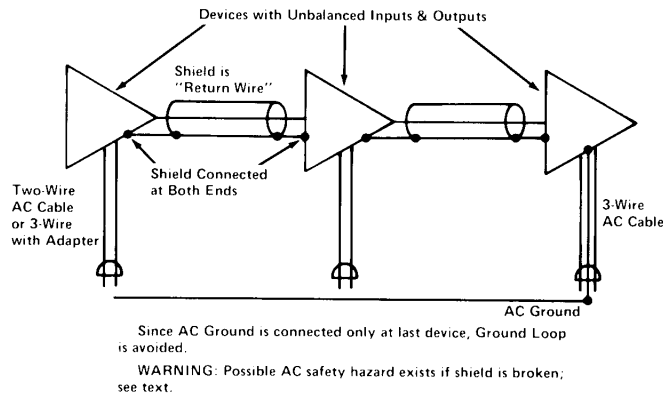

Fig. 51 — Avoiding Ground Loops in an Unbalanced System

In any audio system, there are numerous ways by which ground loops can be created. For example, if a microphone feeds two mixers through a splitter device, and the two mixers are AC grounded through their power cables, a ground loop is formed. In this case, it's better to lift the shield leading from the microphone to one of the mixers than to lift the AC ground of one of the mixers. This procedure not only preserves the safety of the AC ground, but may actually provide better noise suppression. If you learn to look for these potential problems as a system is designed, you can avoid much of the last-minute troubleshooting that is so often necessary to get rid of hum and noise.

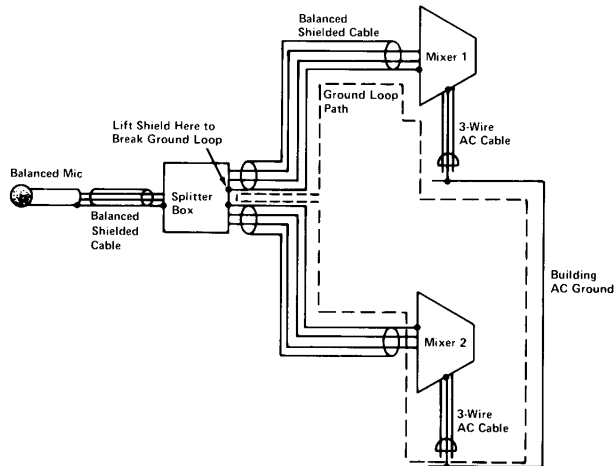

Fig. 52 — Avoiding a Potential Ground Loop when using two Mixers and a Mic Splitter.

For safety reasons, the final ground point in a system should actually be earth ground. Electrical codes always require that the building's AC ground be connected to earth ground at the building's AC service entrance. By connecting the sound system ground to earth, instead of connecting it to some arbitrary three-prong AC outlet, you avoid any noise that may be traveling along the building AC ground wire, and you are assured of a good ground for safety, even if the AC ground wire at the outlet is interrupted (See Page SIX 16). A good earth connection can be obtained at a cold water pipe, or by driving a long metal rod into moist ground. Hot water pipes (which are usually disconnected electrically from earth at the hot water heater), PVC pipes (which do not conduct electricity), and connections to cold water pipes which must travel through a water meter before entering the earth are poor choices for earth grounding.

However a cold water pipe running through a water meter that has been electrically bypassed does provide a good ground connection.

It is worth mentioning that systems without ground connections may be capable of interference-free operation. Portable tape recorders and other battery-operated, self-contained audio equipment are not earth grounded. The electronics in airplanes are not grounded to earth (at least not during a flight), yet the equipment operates well. *The purpose of earth grounding a sound system is to keep the chassis of all equipment at the same potential as the AC mains ground for safety.*

Connecting the same unbalanced input signal to both inputs of the P2050 causes a small, but unavoidable, ground loop. To avoid hum pickup problems, keep the area enclosed by this loop as small as possible by running the two cables to the input close together. If the two inputs are "chained," keep the connecting cable as short as possible.

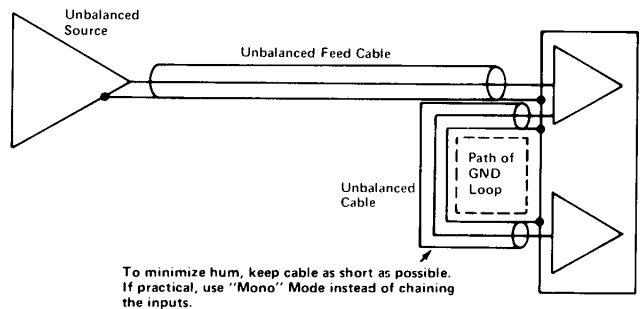
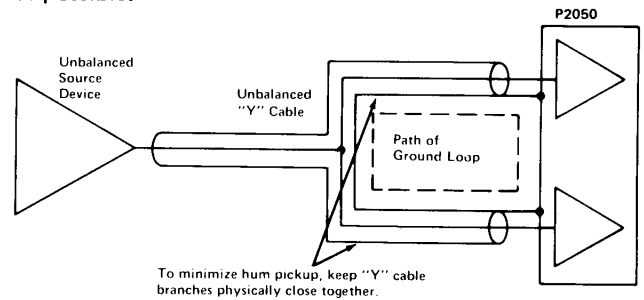

Fig. 53 — Minimizing Hum with Unavoidable Ground Loops

Grounding on the Road

Many of the above procedures are difficult to use on the road. For example, the telescoping shield concept is nearly impossible to use on a portable cable. Similarly, it is a difficult and time consuming process to search for a water pipe ground every time the system is moved from one performance to another. Yet portable systems can be extremely complex, and may have major grounding problems.

The telescoping shield concept can be extended to portable systems by installing a "ground lift switch" on the output of each device, and on the inputs of devices after the mixer. Since microphones are not grounded except through the mixer, there is no need for an input ground lift switch on most mixers. Figure 54 shows a typical ground lift switch installation. By judicious use of these switches, each piece of equipment can be AC grounded for safety without causing ground loops.

Because of leakage currents from equipment in the audio system, and in the house, some noise currents can ride on the AC ground wire and are able to enter the audio system. This problem is usually most noticeable

with sensitive equipment such as the mixer. Lifting the AC ground at the mixer can often solve this problem. However, lifting the AC ground on the mixer also lifts the AC ground on the microphone chassis, causing a safety hazard. Try connecting the mixer and any other sensitive equipment to other AC circuits. The only other apparent solution to this problem is to eliminate the noise on the AC ground, which is not an easy task. Since it has its own ground, a portable AC power distribution system connected to the house service entrance may be the most effective way to avoid all AC noises. Such a system can be designed and constructed by a qualified electrician; check local electrical codes before each use.

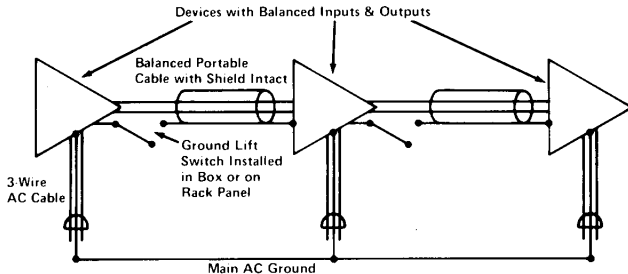

Fig. 54 – Use of Ground Lift Switch

Perhaps the best answer to portable system grounding problems, RFI, EMI, and AC noises, is to develop a versatile grounding scheme. Ground lift switches and adapters, and a portable AC power distribution system allow different grounding techniques to be tried easily and quickly when a problem occurs.

AC: POWER, FUSES, ACCESSORY OUTLETS, WIRING, SAFETY (Applicable on U.S. and Canadian models only.)

The P2050 requires an AC voltage of 105V AC to 135V AC, 50 or 60Hz. If the voltage falls below 105V AC or rises above 135V AC, the P2050 will not operate properly, and may be damaged. At full power with both channels operating into 8 ohms, the P2050 draws approximately 216 volt-amperes, or 1.9 amps at 120V AC (see Figure 13, Page FOUR 2). When a system uses several P2050 amplifiers, check the current capacity of the AC line, and distribute the amplifiers among several AC circuits, if necessary. It is extremely important to always replace a blown AC fuse in the P2050 with the same type and value.

The American Electrician's Handbook by Croft, Carr and Watt, published by McGraw Hill, is a good reference for an understanding of proper AC wiring. Other smaller books, often available in hardware or electrical supply stores, detail simplified residential wiring. We do not suggest that you modify the AC wiring in an auditorium or a club, or anywhere else. Such work should be reserved for a qualified, licensed electrician. But, if you understand proper AC wiring, you will also understand the potential problems of improper wiring, some of which are described below.

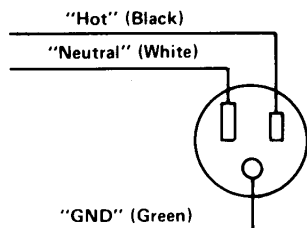

Fig. 55A – Properly Wired 120VAC Outlet

CAUTION: In any audio system installation, governmental and insurance underwriters' electrical codes must be observed. These codes are based on safety, and may vary in different localities; in all cases, local codes take precedence over any suggestions contained in this manual. As set forth in the P2050 Warranty, Yamaha International Corporation shall not be liable for incidental or consequential damages, including injury to persons or property, resulting from improper, unsafe or illegal installation of the P2050 or of any related equipment; neither shall the Corporation be liable for any such damages arising from defects or damage resulting from accident, neglect, misuse, modification, mistreatment, tampering or any act of nature.

Lifted Ground

Broken, or disconnected AC ground wires in existing AC outlets can create shock hazards; so can older, two-wire sockets with no ground. Note that unless metal conduit connects the older, two-wire AC outlet to ground (an uncommon practice except in some public buildings), *the screw on the outlet cover plate is probably not grounded either.* In this case, an AC ground, or earth ground must be located somewhere else.

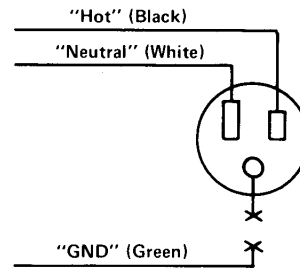

Fig. 55B – 120VAC Outlet with Disconnected AC Ground Wire creating potential shock hazard.

Reversed Polarity

Improper polarity connections, or polarity modifications, can cause reversal of the "hot" and "neutral" AC wires. This can cause shock hazards, and noise in some equipment.

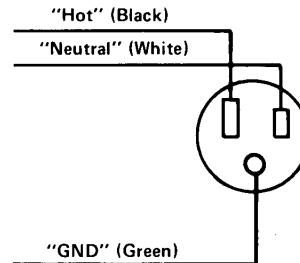

Fig. 55C – 120VAC Outlet with Polarity (Hot and Neutral) Reversed creating shock hazard and causing possible noise.

Lifted Neutral

The "neutral," or return, wire of a 120V AC circuit should be connected to AC ground at the building service entrance where the main AC power enters. However, this neutral is usually a center tap from a 240V AC circuit; if it becomes disconnected at the service entrance, a varying voltage will appear at the AC outlet, which may rise as high as 240V AC, depending on the load on each circuit. This poses shock hazards, and can easily cause equipment damage.

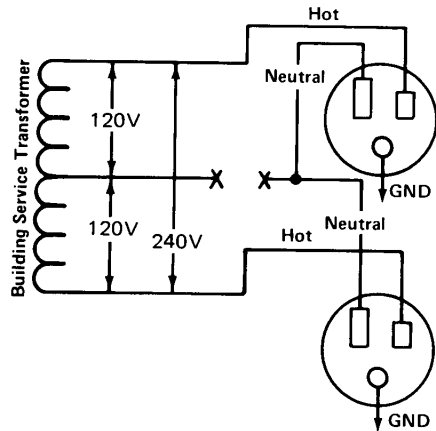

Fig. 55D – 120VAC Outlets with Lifted Neutral. Outlets will operate with voltage varying from 0 to 240VAC creating shock hazard and causing possible equipment damage.

240V AC on 120 AC Outlet

It is possible, though illegal and dangerous, for a 240V AC circuit to be connected to a 120V AC outlet as shown in Figure 55E. Fortunately, this rarely occurs. In an older building, it may have been done to allow 120V AC wiring to carry the 240V AC voltage needed to run lighting equipment. If the P2050, or some other audio device, is plugged into such an outlet, the AC line fuse will blow almost immediately, but some equipment may still be damaged. In addition, this type of outlet poses a shock hazard.

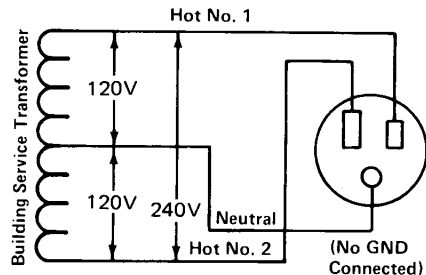

Fig. 55E – 120VAC Outlet with a 240VAC Circuit connected to it. This is a highly dangerous and illegal connection.

120V AC Outlet Connected to Dimmer Circuit

Possibly more common than the 240V-wired 120V outlet is the connection of a 120V AC stage outlet to a lighting dimmer circuit. This may have been done to allow lighting to be controlled on stage from a remote location. Connecting an outlet to a dimmer is a poor practice, and the light dimmer can decrease the voltage in the circuit. Some dimmers are capable of raising the AC voltage. In either case, audio equipment connected to the circuit may suffer damage, and shock hazards are also possible.

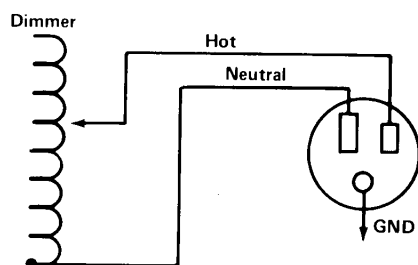

Fig. 55F – 120VAC Outlet connected to a Light Dimmer Circuit, a dangerous and illegal connection.

The best way to avoid all kinds of AC mains problems for permanent or portable systems is to check the voltage and polarity of the outlet yourself – before plugging in any audio equipment. Three wire AC circuit testers are available at most hardware and electrical stores, and will allow easy polarity and ground continuity checking of all outlets. While these testers may show that an outlet has an extreme over-voltage condition (the tester may burn out), the tester may not show less extreme, but still serious, over-voltage conditions. Also, even though such testers may display continuity to ground at the third pin of the AC outlet, the resistance in the ground may still be high enough to warrant the use of a separate earth ground. Thus, it is also a good idea to carry a small voltmeter for verifying the actual voltage at an AC outlet, and to establish a direct path to earth ground that does not rely on the AC mains. Some commercially available AC plug strips have an AC voltmeter built in, or you can install a panel mount meter that reads voltage *before* equipment is connected to the AC circuits in an equipment rack.

Even if the voltage and polarity of the AC outlet are correct, the line may be “soft,” that is, it may not be capable of sustaining proper voltage under load. Monitor the AC line voltage when the P2050 is operating near full power. If the AC line voltage falls below the minimum rated for the P2050 (105 volts rms), the P2050 will not operate properly, and could conceivably sustain damage.

Lifting the AC ground to an audio device, while it *may* solve some noise problems, also lifts the safety feature for which the AC ground was originally designed. If you must lift the AC ground, be certain that the AC ground is carried through to that piece of equipment via the shield of a signal cable, or by some other means.

Other Safety Considerations

While it may seem obvious, the P2050 does weigh 16 lbs (7.2 kg), and should be adequately mounted to prevent it from falling onto other equipment or people. Also, while less obvious, the *speaker output terminals of the P2050 can deliver as high as 20 volts rms, and under certain conditions, this could present a shock hazard.* It is common practice in the audio industry to use “male” connectors to carry output signals, and “female” connectors for inputs. For speaker level signals, however, it may be safer to reverse this convention, or to use “recessed male” type connectors as outputs to avoid the possibility of coming into contact with the output voltage of the P2050.

MONO OPERATION

Connections

With power OFF, move the rear-panel STEREO/MONO switch to the MONO position. After placing the amplifier in MONO mode, connect a mono input signal, such as a single output from a mixer or other source, to the P2050’s Channel A input. Do not connect anything to the Channel B input.

Connect the speaker load to the two red terminals (+) on the P2050’s outputs as shown in Figure 56. Do not connect either speaker wire to ground as this would short out one channel of the P2050, and would severely cut the power available to the speaker load.

SIX18

Use the Channel A attenuator to control the power (signal) level. Keep the Channel B attenuator in its "infinity" position (maximum attenuation).

In the "mono" mode, the P2050 will produce a full 95 watts into a 16-ohm load. The voltage output from the P2050 in the mono mode is approximately 39 volts rms; and since it can drive even highly reactive loads with complete stability, it is suitable for driving constant voltage 25V commercial sound speaker lines. The P2050 can offer cost savings when compared to multiple, low-power amplifier installations. In addition, the P2050's performance specifications far exceed most commercial sound amplifiers.

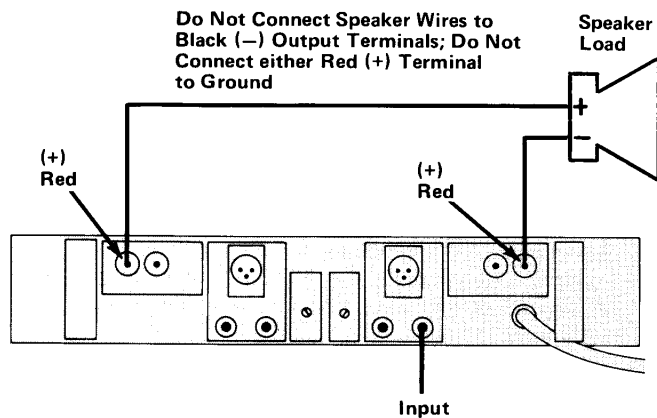

Fig. 56 — Output Connections for Operating P2050 in "Mono" Mode

SECTION SEVEN¹

APPLICATIONS

BIAMPLIFICATION AND TRIAMPLIFICATION

Biamplication, or "biamping," triamplication, or "triamping," all refer to the use of separate power amplifiers to cover separate portions of the audio spectrum.

The traditional, non-biamped speaker system is diagrammed in Figure 57A. The crossover network, which routes the high and low frequencies to their respective speakers, is located in the circuit *between* the power amplifier and the speakers. A large system may contain many power amplifiers, crossovers, and speakers.

Figure 57B diagrams a biamped speaker system, and shows the crossover located in the circuit *before* the power amplifiers, and a separate power amplifier for the high and low frequencies. A triamplified system has an extra crossover section, another power amplifier, and a woofer, midrange and tweeter. Alternately, it has a woofer, tweeter and super-tweeter.

The crossover for a biamped system is a low level crossover since it processes low power signals. It may also be called an active or electronic crossover since it is usually an active device using transistors, tubes, and/or IC's. Some low level crossovers are passive, having no transistors, tubes, or IC's. All high level crossovers used in non-biamped speaker systems are passive and they must process the full power of the power amplifier.

There are any number of good reasons for taking a biamped or triamplified approach to a professional sound system. One reason is that a biamped system can actually provide more headroom per watt of amplifier power than a system with a traditional, high level, passive crossover.

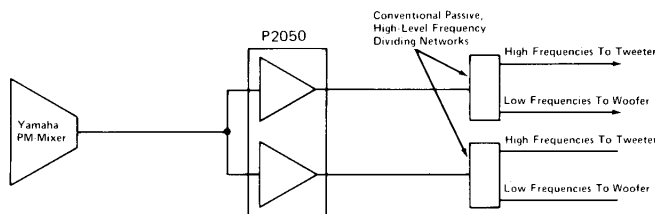

Fig. 57A – System using Conventional, Passive/High-Level Frequency Dividing Networks.

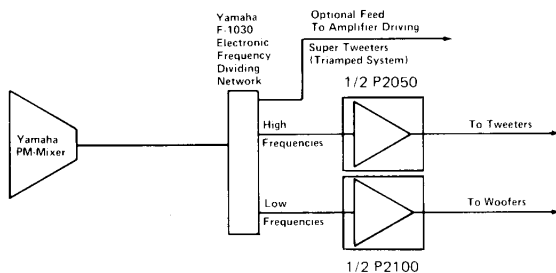

Fig. 57B – Biamped System using Yamaha F1030 Electronic Frequency Dividing Network, and Yamaha P2050 and 2100 Power Amplifiers.

Headroom

Program material (music or speech) is made up of many different frequencies and their harmonics. Most music, especially popular music, is bass heavy; that is, there is more energy at low frequencies than at higher frequencies. When both high and low frequencies, such as a flute and a bass guitar, are present in a program, the high energy bass frequencies can "use up" most of the power in a power amplifier leaving none for the high frequencies. The result can be severe clipping of the high frequency material. With an electronic crossover, the high frequency material can be routed to its own power amplifier, avoiding the clipping problem. This results in an effective increase in headroom that is *greater* than would be obtained by simply using a larger, single power amplifier.

Figure 58A shows a low frequency waveform from a power amplifier output. The peak-to-peak voltage of the waveform is 84 volts, corresponding to 30 volts rms. If this voltage were applied to an 8-ohm speaker load, the power level would be 110 watts, which is equal to the peak output of Yamaha's P2100 professional power amplifier into an 8-ohm speaker load.

Figure 58B shows a high frequency waveform from a power amplifier output. The peak-to-peak voltage, rms voltage, and power into an 8-ohm speaker load are less than shown in Figure 58A and correspond to a 7 watt output into an 8-ohm load (21.2V P-P, 7.5V rms). The levels of these high and low frequency waveforms are typical of musical content.

Figure 58C shows the effect of adding the signals of Figure 58A and Figure 58B, corresponding to a low frequency note and a high frequency note being played at the same time. Note that the total peak-to-peak voltage (which would be 105 volts if it were not clipped) is greater than the peak-to-peak voltage of either signal by itself. For an amplifier to produce this

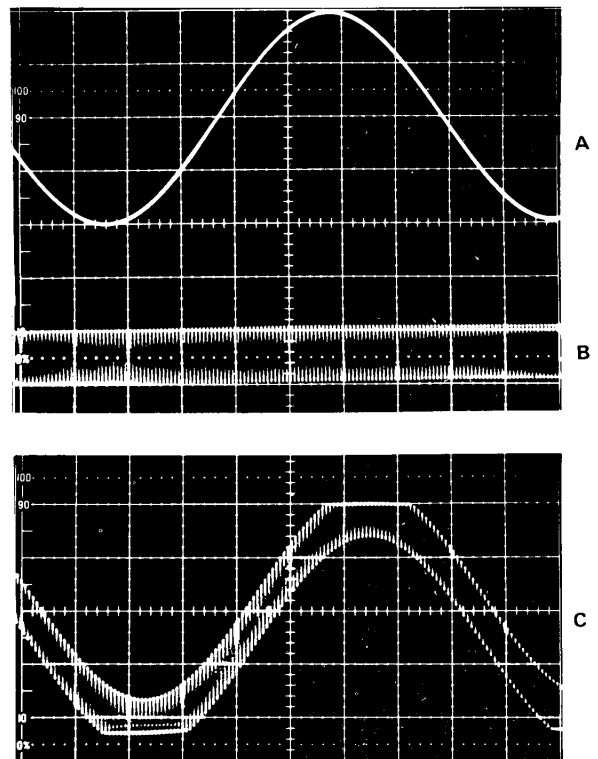

Fig. 58 – Advantages of Biamplication

SEVEN²

voltage into an 8-ohm load, it must be rated at 175 watts (power is proportional to voltage squared). Since the P2100 is rated at 110 watts peak, this waveform is clipped, especially the high-frequency component.

If the same two waveforms in Figure 58A and Figure 58B were reproduced by two separate amplifiers, the total amplifier power needed would only be 117 watts (the sum of the two powers $110 + 7$), not 175 watts. This power could be provided by one P2100 and one P2050 amplifier. Thus, using two power amplifiers to produce these two waveforms reduces needed amplifier power capacity. Or, if you use two P2100 amplifiers, there is a substantial increase in headroom.

NOTE: This headroom discussion presumes the waveforms add coherently. In practice, biamplification may offer less of a headroom improvement than suggested by these mathematics.

Efficiency

A passive crossover is made up of resistors, capacitors, and inductors. The resistors in the crossover "use up" some power, as do the losses in the capacitors and inductors. By removing the passive crossover, these losses are also removed.

Damping

Damping was discussed on Page FOUR 7. With reference to that discussion, any impedance inserted between an amplifier's output terminals and a speaker's input terminals, reduces the damping factor; a passive crossover is such an impedance. Thus, biamplification, by removing the passive crossover improves the effective damping factor.

Distortion

An electronic crossover avoids any possible nonlinearities that might be caused by a passive crossover. This avoids one source of distortion. Also, as previously explained, an electronic crossover reduces clipping distortion by adding headroom.

If clipping does occur, amplifier-caused harmonic distortion may be less audible in the biamplified or triamplified system. For example, if the power amplifier in a conventional system clips during a very powerful, low frequency note, unwanted harmonics are generated. The conventional system would pass the harmonics through the crossover to the tweeter, where they would be audible. In a biamplified or triamplified system, there is no crossover after the power amplifier. Thus, the clipped low frequency note and its harmonics would be restricted to the low frequency driver. Since the low frequency driver is less sensitive to high frequencies than the mid or high frequency drivers, the high frequency harmonics would be attenuated, which would decrease the audible distortion.

Dynamic Frequency Response Shift (also see Page FOUR 6)

When the peaks of a complex waveform are clipped off by inadequate headroom, two things happen. First, since these peaks are usually high frequency information, the high frequencies are lost, or reduced severely. At the same time, the clipping creates new harmonics of the input frequencies. These two factors can be considered to be changing the frequency response of the system on a dynamic (changing) basis, depending on the amount of clipping present.

When to Use a Traditional, Passive Crossover

In small sound systems, where high sound levels are not needed and economy is a major consideration, a speaker system with a traditional, passive crossover network may be the best choice. For example, Yamaha's

S4115H, S0112T and S0110T are excellent as stage monitors, or as main speaker systems for small to medium sized clubs. For larger installations, a biamplified or triamplified system will not only perform better than a system with passive crossovers, but it will probably cost less too; the increased efficiency and headroom allow fewer amplifiers and speakers to produce the same sound level, and fewer crossovers are required.

Realizing the Advantages

To realize the advantages of a biamplified or triamplified system, the electronic crossover must be able to work well with a variety of different power amplifiers and speaker systems. In addition, because it plays a critical role in the sound system, the electronic crossover must be highly reliable, and its performance must be as good as, or better than, any other component in the system. Yamaha's F-1030 electronic frequency dividing network (electronic crossover) meets these needs. It is an excellent choice for any biamplified or triamplified system.

Criteria for Biamped Systems Crossover Frequency and Slope

There is a freedom of choice available to the designer of the biamplified or triamplified system that is not available to the designer of a non-biamplified system. The added advantage of being able to choose crossover frequency and slope means that the system can be carefully optimized for a specific application, or it can be made highly versatile for use in a wide variety of applications.

Most manufacturers of quality speaker components carefully specify both power capacity and frequency range. The choice of crossover frequency can be based on this information. For example, if a high frequency driver's power capacity is rated at 20 watts of pink noise from 2kHz to 20kHz, a crossover frequency of 2kHz or higher is a good choice. A lower crossover frequency might allow over-exursion of the driver's diaphragm, leading to premature failure. If the system is biamplified, the woofer will be chosen to complement the high frequency driver's response. If the system is triamplified, both a woofer and a midrange driver or a super tweeter must be selected so that the frequency ranges of all the components complement each other. Preferably, there should be some overlap in the frequency range of each successive driver.

The choice of crossover slope involves a tradeoff between speaker protection and phase shift. A low slope rate of 6dB/octave will produce a smooth system response with minimum phase shift, but it may not adequately protect high frequency drivers from excessive low frequency energy or low frequency drivers from excessive high frequency energy. A high slope rate of 24dB/octave or higher will protect the drivers better, but can introduce more phase shift than a crossover with a lower slope rate. 12dB/octave and 18dB/octave are widely used, and are good compromises. 12dB/octave is the most common choice, but 18dB/octave can provide a little extra protection for sensitive components, especially high frequency drivers. Again, decisions should be based on a careful study of the abilities of the individual components, and of the system requirements.

One common method of designing a three way system, with woofers, midrange, and high frequency drivers, is to biamp the system between the woofers and midrange, and to then use a passive, high level crossover between the mid and high frequency drivers. Since there is generally less energy in the high frequency

range, the extra headroom and efficiency that would be obtained by triamping may not be needed. This compromise will usually save money without adversely affecting performance or reliability.

Selection of a Crossover (Dividing Network)

There are only a few passive, high level crossovers on the market that are suitable for professional sound systems. Those that are built into a finished speaker system, such as Yamaha's S4115H, S0112T and S0110T, are exceptions. Because of the limited selection, a custom designed system with passive high level crossovers usually has to be designed around the crossover instead of around the drivers. Still, the crossover should meet certain criteria. It should have an impedance equal to the desired speaker system impedance (the impedance of the woofer, midrange and tweeter must be the same for most passive, high level crossover systems). If possible, choose the crossover frequency and slope by the criteria described in the previous paragraphs. Also, choose a passive, high level crossover with adequate power handling (for reliability), good quality components (for low loss and low distortion) and with rugged physical construction.

The designer of a biamplified (or triamplified) system must choose an electronic crossover from an expanded set of criteria. A professional electronic crossover should meet the professional criteria described on Page FIVE 1 for balanced inputs and outputs, and for input and output levels and impedances. In addition, in order to be usable in a variety of professional systems, an electronic crossover should give the designer a choice of crossover frequencies and slopes. Some electronic crossovers restrict the choices, or require hard-wired changes, or plug-in cards to choose different frequencies or slopes.

Yamaha's F-1030 is a two way or three way electronic crossover which gives the designer a wide choice of crossover frequencies selectable for each of three bands by means of front panel controls. The controls are recessed to avoid accidental setting changes. Either 12dB/octave or 18dB/octave slope rates can be selected by internal switches. The F-1030 meets all the criteria for a professional unit, and, in addition, has both XLR and phone jack input and output connectors.

ECHO, REVERB, AND DELAY

Artificial echo is usually obtained in either of two ways: with a tape delay similar to a standard tape recorder, or with a digital delay unit. Repeated echoes are obtained by feeding some portion of the delayed output back to the echo input (regeneration), or by using multiple output taps along a tape or digital delay path. In a tape recorder, the delay results from the time it takes for the tape to travel from the record head to the playback head or heads. In a digital delay unit, the audio is converted to a computer-like digital code using an analog-to-digital converter, delayed by shift registers, and then reconverted to audio using a digital-to-analog converter. Other methods of obtaining time delay are available, from "bucket brigade" (analog) time delay units to a technique where a microphone is inserted in one end of a length of tubing and a speaker at the other end.

Besides its use as an effect, a time delay device can be a very useful tool in commercial sound systems. If two speaker systems, which are fed by the same signal, are separated by more than about 30 feet, a listener can hear a distinct echo. By slightly delaying the signal to the speaker system nearest the listener, such echoes are avoided. This situation is presented in the Applica-

tions section, in the diagram for a typical system in a theatre. Here there is a primary speaker system at the stage, and a secondary system under a balcony (which cannot be covered directly by the stage speaker system).

COMPRESSION AND LIMITING

Dynamic range is the difference, in dB, between the highest and the lowest volume levels in any audio program (also see Page FIVE 2). A compressor is a device that "shrinks" that dynamic range. The "threshold" of a compressor is the level above which compression begins. The "compression ratio" is the ratio of output level change to input level change, in dB, for any program material above the threshold. A limiter is a compressor with a high compression ratio, usually 10:1 or higher. Often a single device can be used for either compression or limiting, since the distinction depends mainly on the threshold and ratio settings.

Radio stations use compressors and limiters. Limiters keep audio peaks from overmodulating and distorting the broadcast signal (an FCC requirement), and compressors keep the average modulation levels high in order to reach the maximum audience.

The dynamic range of better quality magnetic tape recorders is about 65dB. Since much live program material has a dynamic range of 90dB or greater, a recording studio can use a compressor/limiter to restrict the dynamic range of a program to fit the dynamic range of the tape medium. Special "noise reduction" devices are available for tape recording, and make use of complementary compression and expansion to lower the noise levels on a tape recording and to retain the original dynamic range of the program.

In a paging system, a compressor can keep the average level of different announcers' voices more constant, so that paging can reach noisy areas of a factory or airport more consistently. In addition, because of reduced dynamic range, peaks are lowered, reducing the chance of clipping distortion.

In concert sound reinforcement, or other large sound reinforcement systems, a compressor/limiter can reduce the chance of peak clipping, and can thus help avoid amplifier or speaker damage from large turn-on/turn-off transients, or from sudden, loud feedback. These uses of compressor/limiters are valid for recording studio monitoring as well as for sound reinforcement, although feedback should not be a problem in studio monitoring.

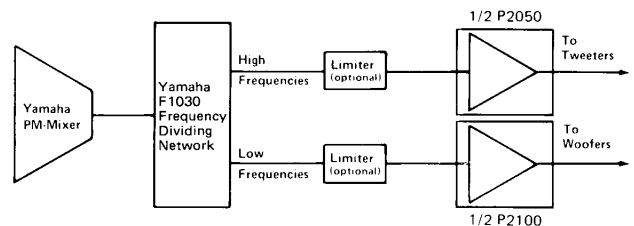

Fig. 59 — Biamplified System showing Placement of Optional Limiters.

While useful, compressors (compressor/limiters) are not cure-all devices. The compressor "makes its decision" to begin compressing by continuously monitoring the program level. Unfortunately, the highest levels are usually low bass notes. Thus the compressor/limiter may compress the high frequencies needlessly when it detects a bass note that is too loud. One solution to this problem is to use a compressor on each output of an electronic crossover on a biamplified or triamplified system so that the compressor acts only on the frequencies in each band. This method requires two or

SEVEN4

three devices and is probably not applicable to broadcast. Another solution is to use a separate compressor on each mixer input that receives excessive program levels.

Another problem with a compressor is that, if it is over-used, it can reduce the quality of sound in a musical performance. Reduced dynamic range is often audible, and a poor quality compressor can add appreciable distortion to a program, especially at high compression ratios.

EQUALIZATION, HIGH AND LOW PASS FILTERS

Equalization, originally, was the process of "equalizing" the levels of the various audio frequency bands for a "flat" system response. The term now encompasses many different devices and techniques that are used for effects purposes as well as to "smooth" the response of a system.

Room Equalization

Whether it be a recording studio, concert hall, airport lounge, or night club, a room has a frequency response of its own. Carpeting, draperies and padded furniture can soak up sound, primarily at high frequencies. The high reverberation time of large concert halls usually affects the low frequency sounds more than the high frequency sounds. For these and other reasons, it may be desirable to shape the frequency response of a sound system to compensate for the response of the room.

Generally, acoustic solutions are the best answers to acoustic problems, especially for severe resonances or excessive peaks or dips in the room response. However, for final smoothing of system response, or for portable systems where acoustic solutions may be impractical, electronic room equalization can be a valuable aid.

There are several different methods of room equalization. Most methods use a specified sound source, such as pink or white noise, or a tone burst which is played through the system. The sound is monitored at one point or at several points in the room using a "real time" monitoring device. "Real time" means that the monitor displays the system response on an instantaneous basis. A graphic equalizer, or other type of equalizer is used to adjust the system response to compensate for response irregularities displayed on the real time monitor.

Equalization can also help to smooth the response of a speaker system, a microphone, or most any type of audio device. However, this can cause problems, as explained below. Frequency response shaping techniques can also be used for special effects: to increase the sizzle of a cymbal crash, to sweeten the sound of a violin or to add warmth to a singer's voice.

Equalizers come in all types and varieties. Some are most suitable for a specific task, others have more general uses.

Graphic Equalizers

A "graphic" equalizer is a multi-frequency, band reject filter, or a bandpass/reject filter. Unlike the input channel equalizers on a mixer, a graphic equalizer can simultaneously operate at several 1-octave, 1/2-octave, or 1/3-octave frequency bands. Most graphic equalizers use I.S.O. standardized center frequencies. (I.S.O. stands for the International Standards Organization.) The units are called "graphic" because most have linear slide controls, and when they are set they create a visual image that resembles the overall frequency response curve of the unit. Some so-called graphic equalizers use rotary controls. A graphic equalizer may provide attenuation

Graphic Equalization can be used to reduce resonant peaks in the overall sound system (which consists of the microphones, instruments, room and speakers. 1-octave EQ illustrated.)

NOTE: Shaded area represents sound level above which feedback will occur. If any frequency is reproduced at a level in the shaded zone, then either the overall sound level must be turned down (lower volume), or the graphic equalizer must be used to reduce the level of the frequency band where the excess level occurs. Proper selection and placement of microphones and speakers can reduce the need for equalization. "He who equalizes least equalizes best" (anon.).

- A microphone picks up a vocal peak at 1kHz, making it necessary to reduce the average level (horizontal dotted line) to some 5dB below the feedback point.
- Lowering the 1kHz Graphic EQ slider about 5dB pulls down the resonant peak and allows the overall volume to be raised several dB. Any further increase of the volume control may cause feedback to occur at several frequencies where lesser peaks occur: an electric bass at 125Hz, an acoustic guitar resonance at 500Hz, and a stage monitor speaker peak at 2kHz that is being picked up by a nearby microphone.
- To allow the average level to be raised further, the 125Hz, 500Hz, and 2kHz Graphic EQ sliders are pulled down slightly. This smooths the overall frequency response and allows maximum loudness throughout the audio spectrum. A natural roll-off at the low and high ends remains, and is preferred by many users. If flatter response is required, it can be achieved.
- If the input channel tone controls were used to bring up the high and low ends of the spectrum, too much lift would occur toward the middle, causing feedback. Also, too much overall bass boost would waste amplifier power and might lead to burned out speakers or excess distortion. By lifting the 62.5Hz, 8kHz and 16kHz Graphic EQ sliders slightly, the response is flattened without unwanted distortion, and without creating feedback.

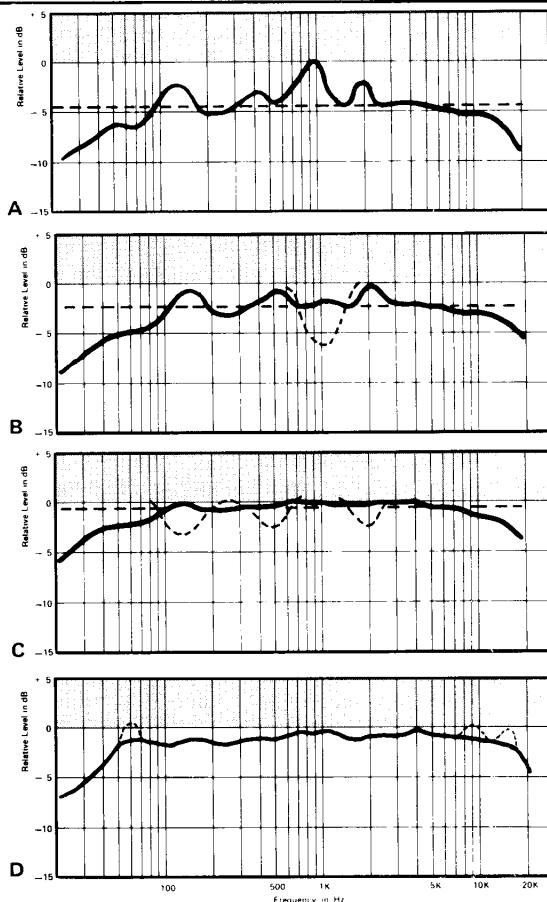

Fig. 60 — How to Use 1-Octave Graphic Equalization

only (band reject), or attenuation and boost (band pass/band reject).

Usually, each speaker feed requires its own channel of professional-type graphic equalization which is installed between the mixer output and the power amplifier input. Stage monitor feeds, for example, may require very different equalization than house feeds. In recording and broadcast applications, the graphic equalization applied to the recording is usually for tonal considerations, and to avoid exceeding the frequency response limits of the medium. At the same time, the studio monitors or audience foldback system might require graphic equalization to suit very different ends.

Professional graphic equalizers are usually more durable than hi-fi type units, and they operate at nominal +4dB (1.23 volts) line levels. The input of a hi-fi type graphic equalizer will probably require padding for use with professional type mixers such as the Yamaha PM-Mixers, and the output level may be too low to drive some common power amplifiers. The P2050's sensitivity is high enough to allow it to be driven by most hi-fi type graphic equalizers. Aside from level and impedance criteria, some graphic equalizers have characteristics that cause the overall response curve to change drastically when one frequency band is adjusted, so two or more bands must be adjusted to preserve a smooth response. Other equalizers maintain a smooth transition to adjacent bands when just one control is adjusted.

Parametric Equalizers

A parametric equalizer is one whose parameters can be varied to suit the application. The parameters include such factors as filter bandwidth (Q), center frequency, and amount of boost or cut. Usually there are several filters, and some parametrics are set up for stereo operation. Each filter section in the equalizer can either cut or boost frequencies within its band, and the ranges of center frequencies available from adjacent filters usually overlap.

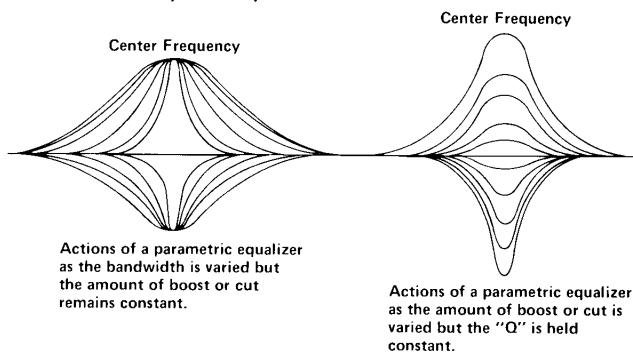

Fig. 61 — Actions of a Parametric Equalizer

A filter adjusted for wide band rejection characteristics (low Q) can perform room equalization in a similar manner to a graphic equalizer, or it can act as a variable frequency cut or boost tone control. In a narrow band reject mode (high Q), a parametric equalizer can be used for feedback control, or to notch out hum or feedback frequencies without subtracting much of the adjacent program material.

Used carefully, a parametric equalizer can be an extremely helpful tool for sound reinforcement or for recording. It should be remembered that, like graphic equalization, excessive boost may reduce system headroom, create clipping and make extreme power demands on amplifiers and speakers. In addition, a parametric

equalizer may "ring" at high-Q (narrow bandwidth) settings. Ringing is caused when a filter begins to act like an oscillator. While ringing may be useful as an effect, it also may cause unwanted peaks in the system's frequency response curve.

Other Equalizers

Tone controls are another type of equalizer. So are a number of the special effects devices, like "wah-wah pedals," "phasers," "flangers," etc. Each of these devices was designed for a special purpose.

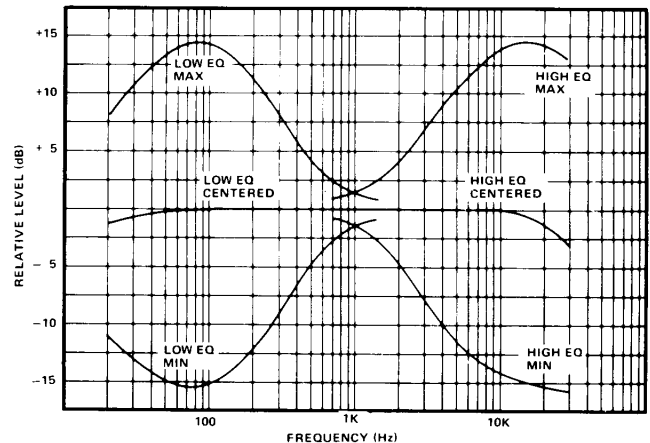

Fig. 62 — Actions of Tone Controls

High pass and low pass filters are special purpose devices. They are sometimes called "horizontal" filters because they do not boost or cut in the same manner as a graphic or parametric equalizer, which would be a "vertical" filter.

High pass filters, which pass frequencies only above their cut off frequency, are used to cut low audio and subsonic frequencies from a sound system. Using a 40Hz or 80Hz high pass filter, for example, reduces dangerous dropped-mic, or turn-on, turn-off transients, etc., but allows all significant program frequencies to pass.

A low pass filter, which passes frequencies only below its cut off frequency, can stop high frequency oscillations and certain RF interference from reaching the speakers.

In commercial sound systems, high and low pass filters cut unneeded frequencies from the system, and thus increase the total capacity of the system to reproduce the frequencies of interest.

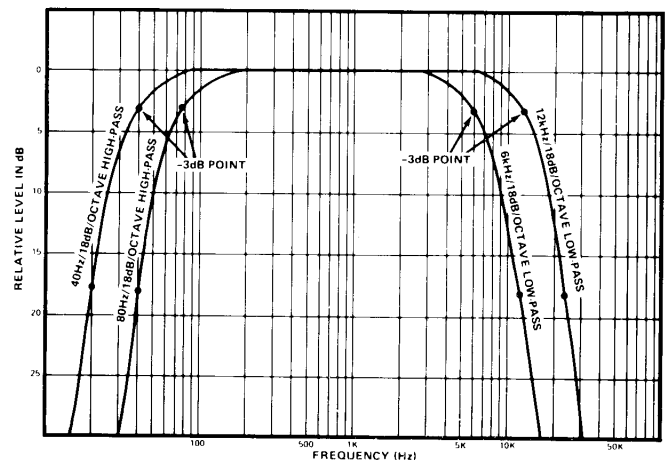

Fig. 63 — Actions of Typical High and Low-Pass Filters

NOTE: P2050 High Pass Filter is 12dB/octave at 20 or 200Hz.

SEVEN6

Equalizer Problems

The previous discussions illustrate some of the many uses of the various types of equalizers. Like any signal processing device, an equalizer can also cause problems. From the power amplifier's viewpoint, the most significant problem that can be caused by an equalizer is clipping of frequencies that have been boosted to extremes. If these boosted frequencies are in the treble range, the clipping may sound like an irritating sizzle that only happens on certain sounds. Similarly, clipping in the low frequencies can cause bass notes to sound fuzzy or muddy, or it can cause mid-range frequencies to be harsh. Yet because the clipping only takes place on certain sounds, it may not be immediately apparent that clipping is the source of the problem. The choice of a cut-only graphic equalizer, rather than a boost and cut device, may help solve the problem; since boost is not available, clipping problems are reduced. With cut and boost graphics, parametrics, or other types of equalizers, the system operator must be aware of the potential for clipping.

SPEAKER PROTECTION

The output power of the P2050 into an 8-ohm load is 45 watts. Not all single speaker systems are capable of absorbing that much power *on a continuous basis*. Most speaker systems, however, are capable of absorbing short duration peaks of considerably higher power than their rated continuous power capacity. The speaker must be protected against the abuses of excessive average power, sudden large peaks, DC current, and frequencies outside its range. The following are methods of achieving some degree of protection against these abuses.

Fuses

Yamaha does not recommend the use of any type of fuse as speaker protection. Fuses are slow-acting devices of inconsistent quality, and do not offer adequate protection for speaker systems. They are mentioned here only because they are used in some systems. Standard fuses may be capable of protecting a speaker against excessive average power, but they are too slow to successfully protect a speaker against sudden peaks. Fast-blow instrumentation fuses, with improved time response, may blow on normal program peaks and needlessly disrupt the program. Slo-blo fuses, on the other hand, may not blow quickly enough to prevent loudspeaker damage due to voice coil overheating. If fuses are used, whenever possible, fuse each loudspeaker separately so that a single fuse failure will not stop the show.

A fuse will protect a loudspeaker against one common fault of a DC coupled amplifier: DC at the output. The slightest DC offset from a direct coupled pre-amplifier will be amplified and appear at the power amplifier's output as a larger voltage with the power amplifier's large current capacity behind it. Even though there is no immediate audible affect (the extra power draw may cause some amplifiers to hum slightly), the loudspeaker absorbs the DC power output of the amplifier. Since it cannot convert this DC power into acoustic power, the speaker converts the DC to excessive heat. Small amounts of DC voltage can shorten the life of a loudspeaker, and any large amount of DC will cause sudden, catastrophic failure. Fortunately, the input of the P2050 is not DC coupled so any DC voltages from pre-amplifiers, etc., are not amplified and cannot reach the speaker. The only time DC voltage could appear at the P2050's output would be in the event of a severe electronic failure inside the amplifier, a very unlikely event.

Capacitors

Inserting a non-polarized capacitor in series with a high frequency driver can protect the driver against excessive low frequency energy. The capacitor acts as a 6dB/octave high pass filter. Especially on a bi-amplified or triamplified system, this kind of protection is desirable. In such as system, choose a protection capacitor by the following formula:

$$\text{Value (in microfarads)} = \frac{500,000}{\pi \times f \times Z}$$

(Where $\pi = 3.14$, "f" is the crossover frequency divided by two, and Z is the nominal impedance of the driver.)

The same formula can be used to choose a capacitor to insert in series with a low quality 25-volt speaker transformer to avoid excessive current flow at low frequencies (see Page SIX 13). With a speaker load connected to the secondary, measure the impedance of the transformer primary at the lowest frequency of interest, which will probably be somewhere around 100Hz. Choose the protection capacitor by the above formula with Z = the measured impedance of the transformer, and f = the lowest frequency of interest divided by two.

The voltage rating of the capacitor chosen must be greater than the maximum expected total peak to peak voltage that will ever appear at the driver's terminals. For the P2050, this is equal to the sum of its positive and negative supply voltages, which is 86 volts. The most common types of capacitors used for driver protection are non-polarized electrolytics. Because of the inductance associated with an electrolytic capacitor, it may be paralleled with a mylar capacitor of about 1/10 the value in microfarads to reduce high frequency losses.

Limiters

A limiter is not normally considered a loudspeaker protection device, but it may be one of the best and most practical. A "squared up" or "clipped" waveform causes a loudspeaker cone or driver diaphragm to move to one position and stay there, then move back to the extreme opposite position, and stay there, etc. Because there is still power flowing through the voice coil, but there is no voice coil movement, the power is converted to heat. If a limiter is placed before the power amplifier in a system, the limiter can be adjusted to prevent peaks from reaching a level that would cause the power amplifier to clip. This may avoid burned out loudspeakers.

Transformers

The constant voltage transformers used in some commercial sound systems lend a certain amount of protection to a loudspeaker. They will not pass DC current, and most of them will not even pass subsonic frequencies or very high frequencies, such as RF oscillations. Some transformers have attached protection capacitors for use with high frequency drivers.

Auto-transformers are sometimes used to match speaker impedances. The auto-transformer provides many of the same protections as a constant voltage transformer, with the exception that it is possible for a small amount of DC current to leak through to a loudspeaker because the taps of an auto-transformer are all from the same winding.

Passive Crossovers

Because a passive crossover usually inserts a capacitor in series with the high frequency driver, and often inserts an inductor in series with the low frequency driver (which limits the current reaching it), it can aid

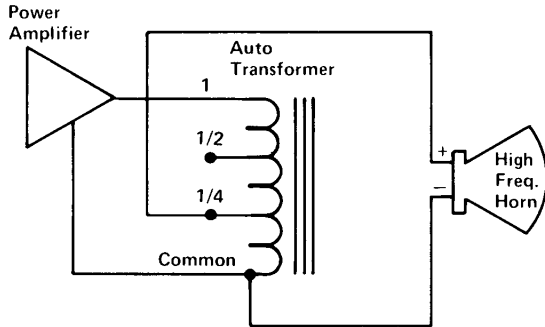

Fig. 64 – Typical use of Auto-Transformer for Speaker Impedance Matching which also helps protect the Speaker from damage caused by DC at the Amplifier's Output.

in loudspeaker protection.

High Pass and Low Pass Filters

The functions of high and low pass filters were discussed on Page SEVEN 5. Because these filters limit the subsonic and supersonic frequencies reaching the loudspeakers, they can help prevent loudspeaker damage.

SPECIFIC APPLICATIONS

The following diagrams illustrate a few of the many possible applications of the P2050 in all types of sound systems.

Studio Monitoring

The diagram in Figure 65 shows the P2050 used as a studio monitor amplifier. Part of the system is bi-amplified. Alternately, the Yamaha F-1030 crossover could be used for a tri-amplified system with a P2100 or a larger amplifier, such as the P2200, for the woofers.

The P2050's dB-calibrated attenuators are a distinct advantage in this application. The operator can reduce the level of a particular set of monitors, such as the studio monitors during a "take," and bring them back up later to exactly the same setting.

Sustained power output, exceptionally low distortion, wide bandwidth and low phase shift, combined with high reliability make the P2050 an ideal choice for a studio monitor amplifier.

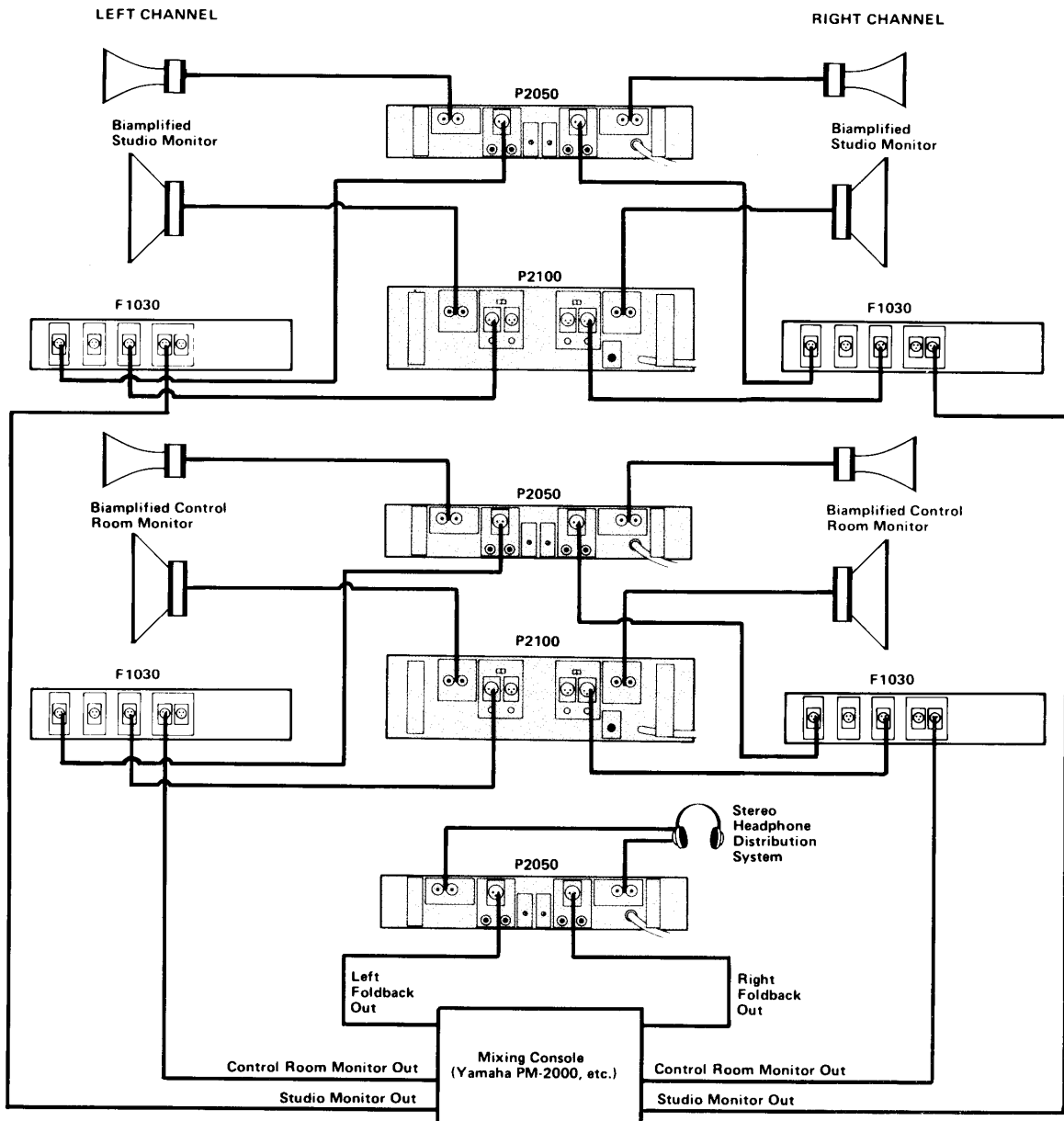

Fig. 65 – Recording Studio Monitor System (Bi-amplified with Yamaha F-1030 Frequency Dividing Networks)

SEVEN8

Concert Sound

Figure 66 illustrates the P2050 in a typical setup for concert reinforcement. Note that there are a number of completely separate feeds, with separate limiters, equalizers, electronic crossovers and power amplifiers.

Individual channels can be easily checked during setup by turning down the calibrated attenuators on all other channels. When check out is finished, it's easy to bring back the levels to previous settings.

Besides having exceptional specifications, the P2050 is extremely reliable, and is built to take the abuses of the road. Bracing the rear of the P2050 in a portable rack will "ruggedize" it for the most extreme cartage requirements. (The P2050's AC coupled input will not pass dangerous DC signals, further protecting speakers. In addition, the P2050's protection circuits smoothly limit power during severe thermal and power demands (see Page SIX 13).

**Amplifiers Operating in "Mono" Mode:
A separate bank of amplifiers is used
for each channel.**

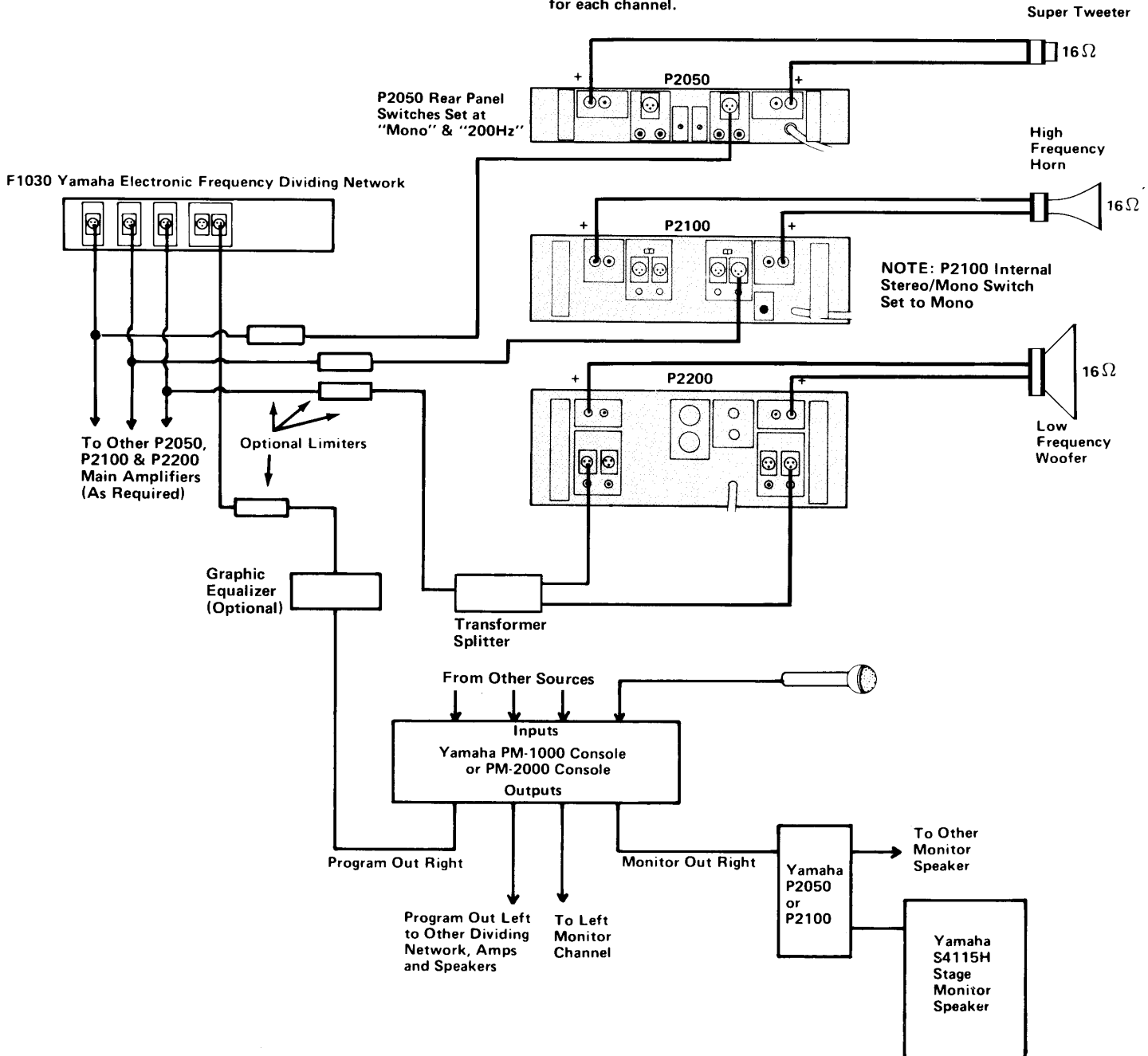

Fig. 66 — Concert Sound System

Portable Instrument Amplifier

Figure 67 details possible connections for a portable setup for a guitar amplifier. Ideal for this application, the P2050 can easily reproduce the high power notes that may be clipped off by lower power instrument

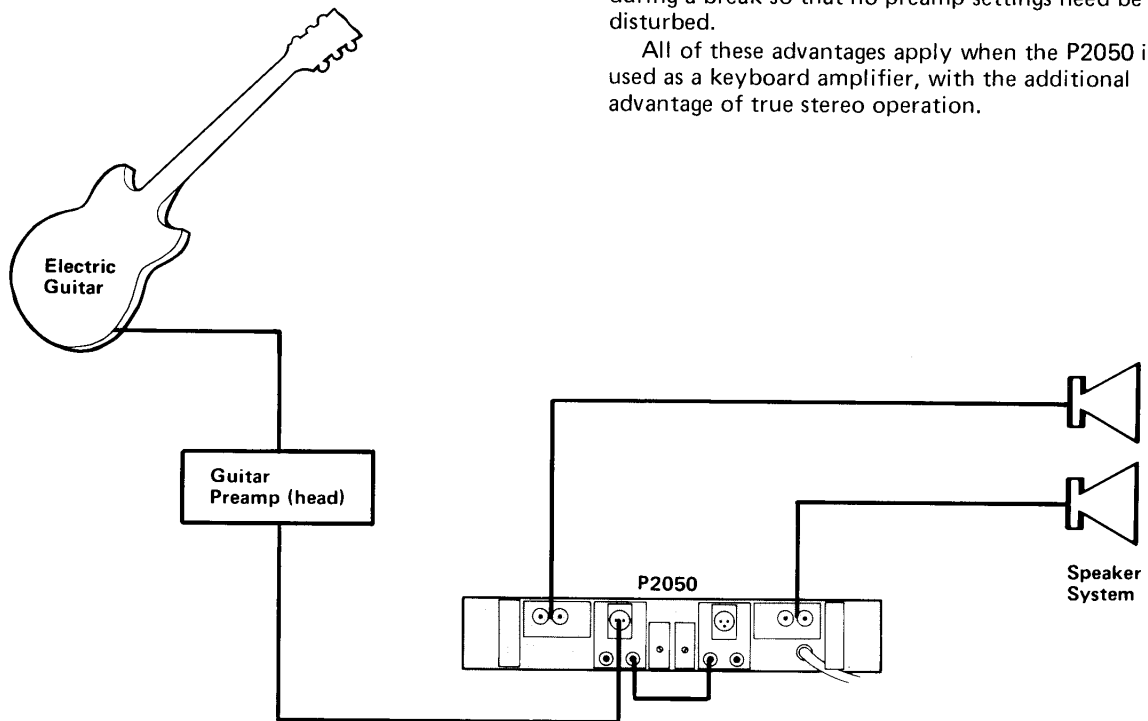

Fig. 67 – Instrument Amplifier

amplifiers. Thus, it will “clean up” the sound. In addition, the P2050 is sensitive enough and its input is of sufficiently high impedance that it can be driven by the output of most hi-fi or semi-pro type preamps. The P2050’s calibrated attenuators can be turned down during a break so that no preamp settings need be disturbed.

All of these advantages apply when the P2050 is used as a keyboard amplifier, with the additional advantage of true stereo operation.

Headphone Distribution System

(Illustrations on next page.)

There is often a need to distribute audio to one or more sets of headphones, sometimes with individual level controls for each set. While many mixers and consoles have phones outputs, some are capable of driving only one or two sets of headphones, and others require an external power amplifier to drive even one set. The P2050 can power many sets of headphones, either mono or stereo (Figures 68A and 68B).

It is important to determine the type of headphones involved: high impedance (600 ohms or higher) or low impedance (4, 8 or 16 ohms). A large number of high impedance phones may be connected in parallel across the P2050 output; they draw little power, and their combined impedances are still well above the amplifier’s 2.5-ohm current-limiting protection circuit threshold. If low impedance phones are used, their combined parallel impedances must be considered; a good way to ensure that the amplifier will not be overloaded is to use 10-ohm “build-out” resistors on each headset. Because a substantial amount of power may be dissipated, the resistors should be rated at a minimum of 5 watts (if potentiometers are used, they should be rated at a minimum of 10 watts).

Y-cables may be used for multi-headphone distribution, but a more reliable and convenient approach is to use single input/multi-output distribution boxes. These are easy to construct. Figures 68C and 68D illustrate two types of stereo headphone distribution boxes, one with and one without volume controls.* If the box is built entirely with stereo phone jacks, then special Headphone extension cables (with tip/ring/sleeve phone plugs) will have to join the amplifier to the box(es). An alternative is to use stereo phone jacks for the headphones, but to use XL connectors for the input and an extension output; then standard mic cables can link the amplifier to the box(es)

CAUTION: When using XL connectors pre-wired in studio application, install a male connector in the wall to carry the power amp output. This avoids any possibility of accidentally plugging the power amp output into a microphone input. Parallel-wired male and female XL connectors mounted in each box facilitate additional boxes using the same standard mic cables.

*The schematics and photos for these boxes are provided courtesy of Windt Audio, Inc., 1207 N. Western Avenue, Los Angeles, CA 90029 (Phone (213) 466-1271).

SEVEN10

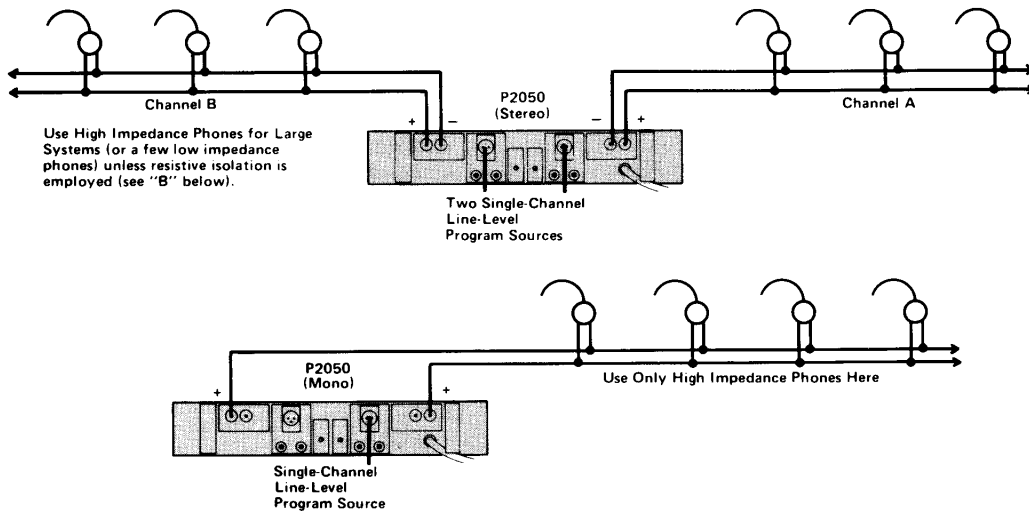

Fig. 68A – Two versions of Mono Headphone Distribution Systems

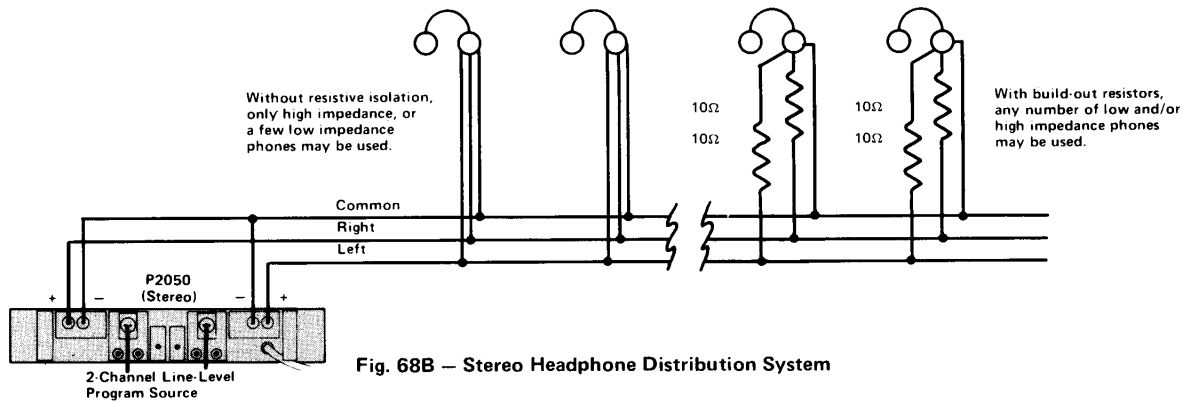

Fig. 68B – Stereo Headphone Distribution System

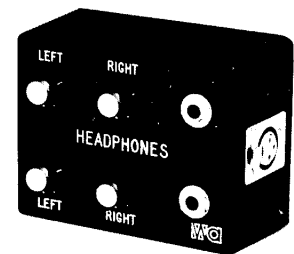
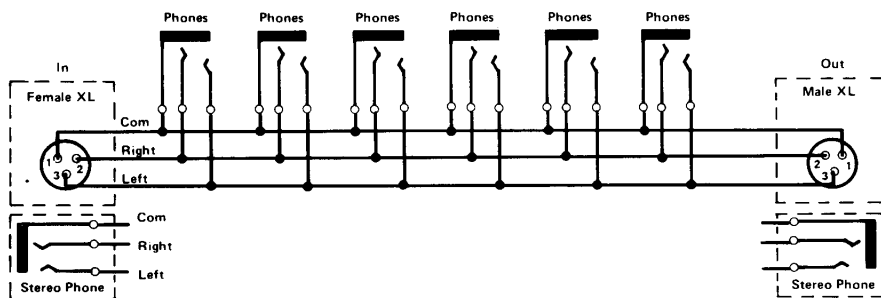

Fig. 68C – Headphone Distribution Box for use with High Impedance Phones only.

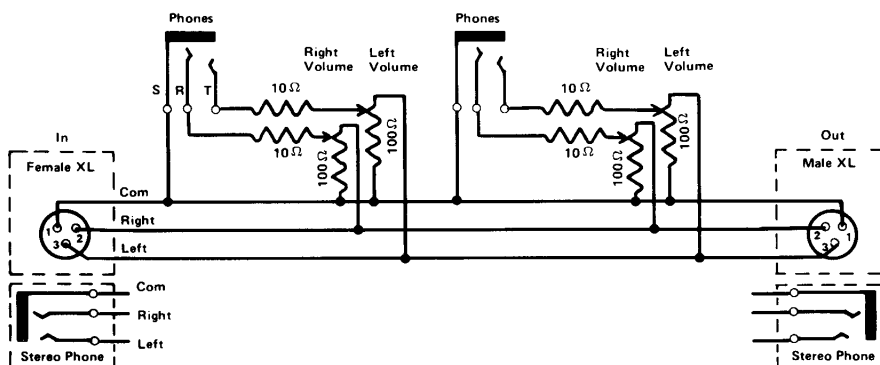

Fig. 68D – Headphone Distribution Box with Volume Controls, for use with Low and/or High Impedance Phones.

Discotheque

Disco systems, such as the one diagrammed in Figure 69, really test an amplifier's endurance. The music from a record album may be highly compressed so that its average power content is high, and the amplifier may not get even a short rest during many hours of operation each night.

With its massive heat sinks and sustained power output capabilities, the P2050 is a highly reliable amplifier for disco use. In addition, the P2050's low distortion will produce clean sound, the kind of sound that avoids listening fatigue — an important consideration for high sound level operation. For larger floors where higher power is required, we recommend using our P2100 or P2200 amplifiers.

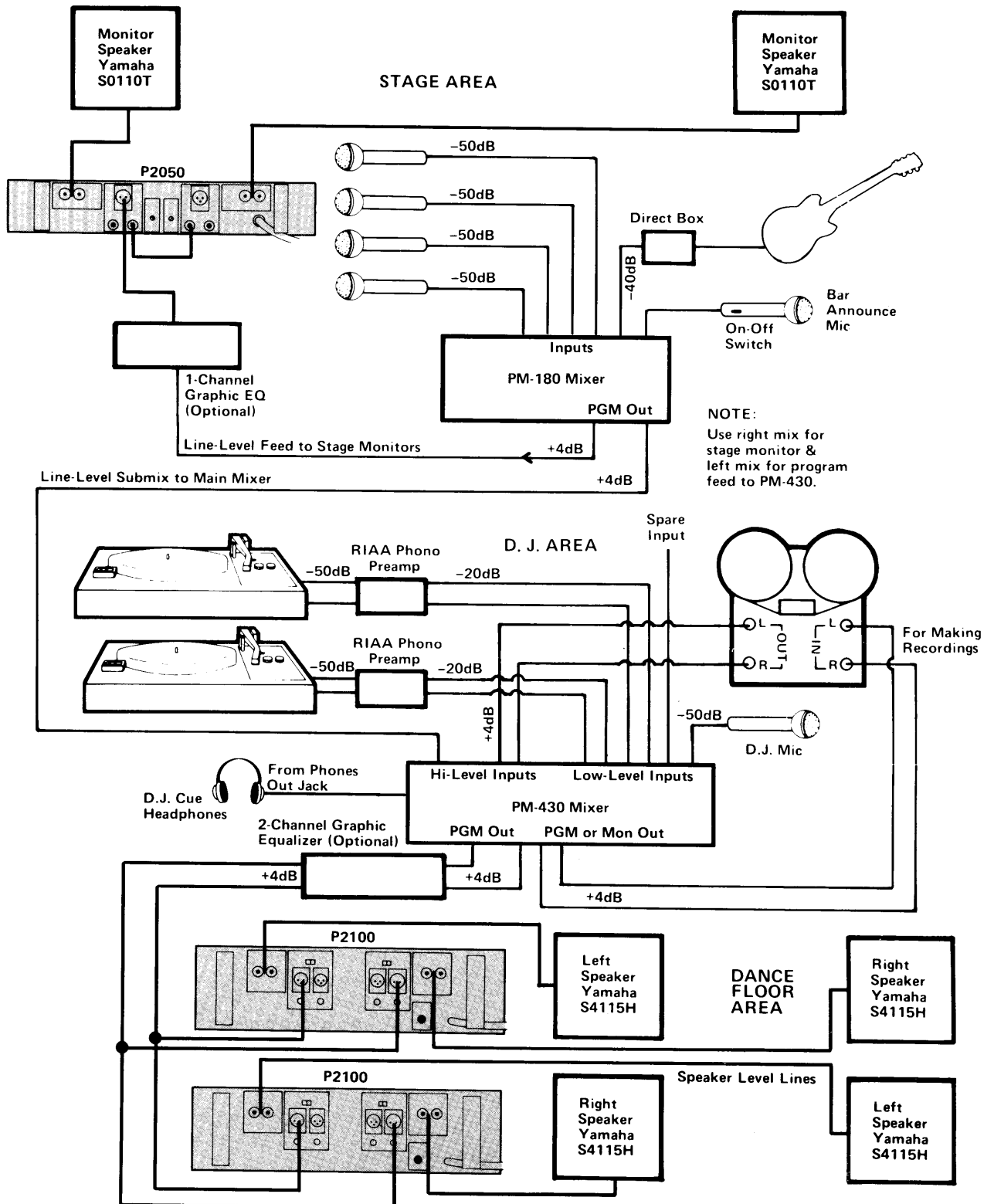

Fig. 69 — Combination Disco/Live Club Sound System Setup

SEVEN12

Commercial Sound Systems

The factory paging/background music system is Figure 70 also shows the P2050 used in "mono" mode. One P2050 feeds the main factory areas with a highly-compressed signal. The other P2050 feeds office areas with a separate, less compressed signal that has been equalized for a more natural sound.

The P2050 is exceptionally stable, even under highly reactive constant-voltage line loads. In smaller systems and in larger systems, the P2050's dB-calibrated attenuators help the installer and operator achieve optimum system performance. In fact, the P2050 can improve just about any commercial sound system design, from auditoriums and other reinforcement systems to electronic church organs, shopping centers or airport paging.

Other Uses

The P2050 is a basic tool for all types of sound systems, yet it is not limited to sound systems alone. Due to its own exceptional performance, the P2050 will not degrade the performance of even the highest quality test oscillators, noise generators, tone burst generators, function generators or other equipment.

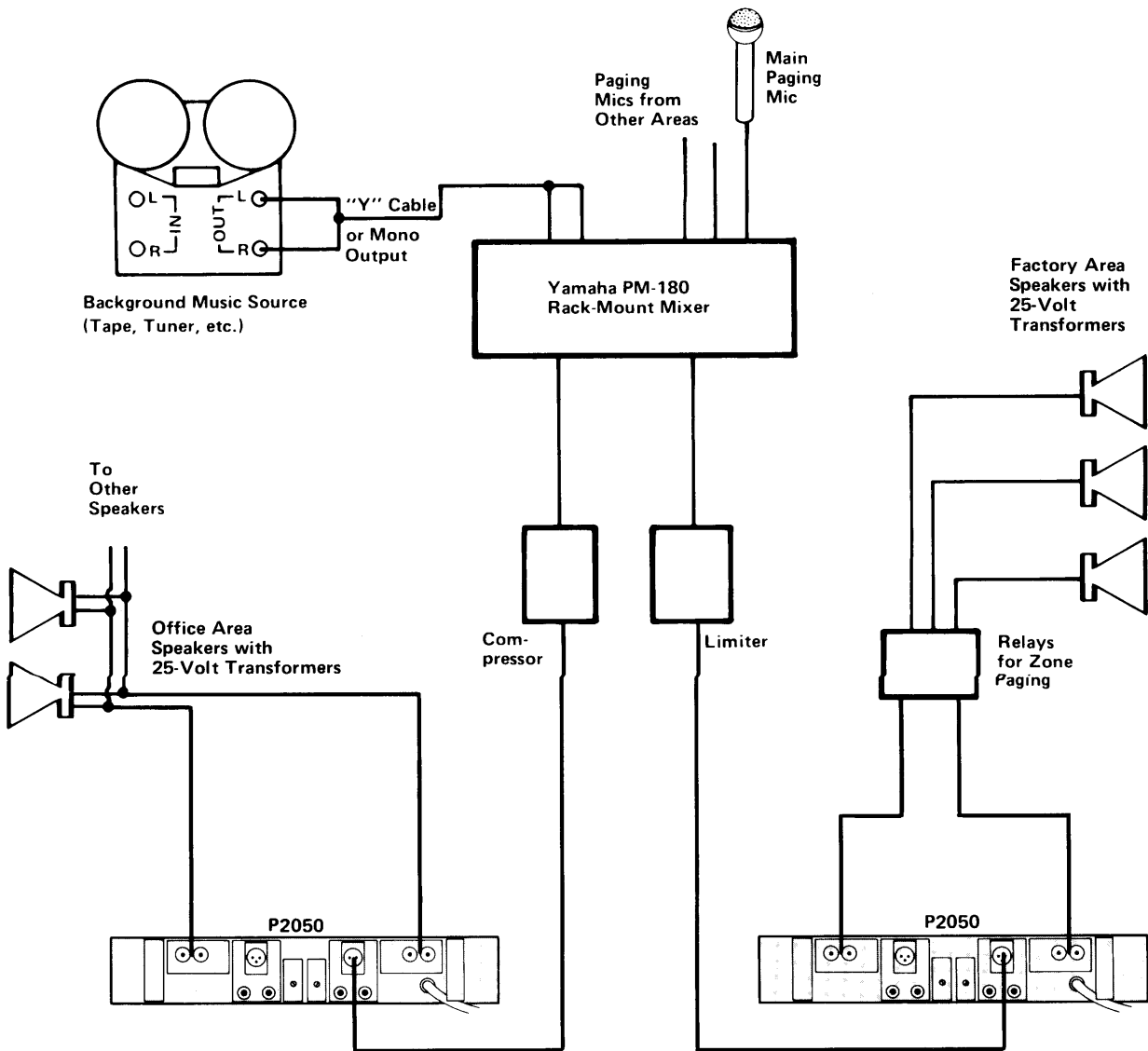

Fig. 70 – Factory Paging System

APPENDIX

DEFINITION OF TERMS: dB, dBV, dBv, dBm and dB SPL

The term dB, which means decibel (1/10th of a Bel), expresses a ratio. The dB notation allows us to represent very large ratios with small numbers, which are easier to understand and use. The ratio in dB of two power levels is equal to 10 times the logarithm (base 10) of their simple numeric ratio:

$$\text{dB} = 10 \log P_1 / P_2$$

The ratio in dB of two voltages (V_1 and V_2) or sound pressure levels (P_1 and P_2) is equal to 20 times the logarithm (base 10) of their simple numeric ratio:

$$\text{dB} = 20 \log V_1 / V_2$$

Examples:

Power: The ratio in dB of 100 watts and 50 watts.

$$\text{dB} = 10 \log 100/50 \quad \text{Answer: } +3\text{dB}$$

Note that this means that 100 watts is 3dB above 50 watts. If we had compared 50 watts to 100 watts ($\text{dB} = 10 \log 50/100$), the answer would have been -3dB . Similarly, any time the ratio of two powers is 2:1, their ratio in dB is $+3\text{dB}$. When the ratio is 1:2, the ratio in dB is -3dB .

Voltage: The ratio in dB of 100 volts to 50 volts.

$$\text{dB} = 20 \log 100/50 \quad \text{Answer: } +6\text{dB}$$

Note that a ratio of 2:1 in voltage means a ratio in dB of $+6\text{dB}$. If the ratio is 1:2, the ratio in dB is -6dB .

SPL: SPL ratios, expressed in dB, are similar to voltage ratios. For example, two SPL levels with a numeric ratio of 2:1 would have a ratio in dB of $+6\text{dB}$. SPL ratios are seldom given as numeric ratios. Simple numeric SPL levels would have units of dynes per centimeter² or newtons/meter².

The term "dB" implies a *ratio*. To express a single, specific quantity in dB, there must be a *reference* quantity. There are standard reference quantities for SPL, voltage, and power, which extend the usefulness of the dB notation system.

dBV or dBv express a voltage ratio. It is not directly related to current or circuit impedance. 0dBV is usually referenced to 1 volt rms, and 0dBv to 0.775V rms.

Example: The level in dBV of 10 volts rms:

$$\text{dBV} = 20 \log 10/1 = 20 \times 1 \quad \text{Answer: } +20\text{dBV}$$

dBm expresses a power ratio. It is related to the voltage or current across a low impedance. The 0dBm reference is 1 milliwatt, which is equal to 0.775V rms in a 600-ohm circuit.

Example: The level in dBm of 1 watt:

$$\text{dBm} = 10 \log 1/0.001 = 10 \times 3 \quad \text{Answer: } +30\text{dBm}$$

dB SPL expresses acoustic pressure (not power ratio). The 0dB SPL reference is 0.0002 dynes/square cm, which is the approximate threshold of human hearing at 1kHz.

NOTE: Since SPL values in dynes/cm² or newtons/m² uncommon, an example is not given.

dB expresses the difference between two levels (power, voltage, sound pressure, etc.) and is a relative term. The difference between +10dBm and +4dBm is 6dB. The difference between -20dBV and -10dBV is 10dB.

dBV and dBm are not numerically equal when dealing with 600-ohm circuits, although they are close; 0dBV is $+2.2\text{dBm}$ at 600 ohms. As the impedance is changed to other than 600-ohms, given a constant voltage, the value of dBV remains constant while the value of dBm changes. For example, consider a $+4\text{dBm}$ output terminated by 600 ohms. The voltage level is $+1.8\text{dBV}$. This circuit has a voltage drop of 1.23V rms, and a power dissipation of 2.5 milliwatts. Assume that the voltage now remains constant, but the termination is changed to 1200 ohms. The voltage level remains $+1.8\text{dBV}$, but the power dissipation drops to 1.23mW, $+1\text{dBm}$. Continuing this illustration, we raise the termination to 47,000 ohms. The voltage level remains $+1.8\text{dBV}$ (1.23V rms), but the power level drops to a mere 32 microwatts, -15dBm .

The above illustration points out that the power dissipation in high impedance circuitry is negligible. Therefore, dBV is most often reserved to express signal levels in high impedance lines and for microphone specification. The term dBm is commonly used to express signal (power) levels in low impedance lines, roughly between 4 ohms and 1200 ohms. However, dBm is also widely misused to express levels in high impedance lines, rather than dBV. This is because at 600 ohms the voltage for a given dBm is not the same as the voltage for the same number of dBm in other impedances. If the source is constant voltage or the input is high impedance, then the voltage level is more important than the power.

Summary:

An increase of 3dB is equivalent to double the power.

An increase of 10dB is equivalent to ten times the power.

A decrease of 3dB is equivalent to half the power.

A decrease of 10dB is equivalent to 1/10 the power.

An increase of 6dB is equivalent to double the voltage or SPL.

An increase of 20dB is equivalent to ten times the voltage or SPL.

A decrease of 6dB is equivalent to half the voltage or SPL.

A decrease of 20dB is equivalent to 1/10 the voltage or SPL.

SPECIAL USE OF dB (volts) IN THIS MANUAL

Assume that a Yamaha PM-Mixer has a constant input voltage, such as the sinewave signal from a test generator. The mixer output then acts very much like a perfect sinewave voltage source because the mixer's output impedance is much lower than the load impedance. That is, even when the load impedance varies from the lowest rated load to an extremely high impedance, the output voltage from the mixer will remain relatively constant. However, the mixer's output power does vary with the load impedance. dBm is a power rating, and if the PM-Mixer's maximum output were rated in dBm, that rating would change with the load impedance. Thus, a dBm-rated output level would be valid only at a single load impedance, usually 600 or 150 ohms.

EIGHT²

It is common to rate a mixer's maximum output in dBm referenced to 600-ohms, and to treat this rating as if it were a voltage rating, even though it is actually a power rating. If a mixer's maximum output is rated at "+24dBm," the rating really means "12.3 volts," which is the voltage produced by a power level of +24dBm into a 600-ohm load. If you realize that by this rating method, "+24dBm" means "12.3 volts," and that "+4dBm" actually means "1.23 volts," etc., then you can accurately interpret the specification. Of course, there are mixers that will deliver 12.3 volts into a high impedance, but cannot sustain this voltage with a 600-ohm load, and such mixers could not be honestly rated at +24dBm. (NOTE: If the mixer's output impedance is 600 ohms or lower, it should be able to sustain the rated output voltage into 600-ohm loads.)

One possible way to avoid the common, but often misused, "dBm" output rating method would be to rate the maximum output of a mixer in dBV or dBv. Since the mixer acts like a voltage source, this would be an accurate rating regardless of the load impedance. Unfortunately, the dBV rating is relatively uncommon in audio, although it is used for some microphone ratings, so it would be unfamiliar to most users and therefore difficult to interpret.

To avoid confusion, we have rated outputs in "dB (volts)," where the dB value is equal to the voltage produced by a numerically equal "dBm" rating in a 600-ohm circuit. By this method, "0dB (0.775 volts)" is exactly the same as "0dBm" for a 600-ohm circuit. Since it is a voltage rating, however, "dB (volts)" is accurate regardless of the mixer's load impedance, so long as the mixer is not overloaded. Also, since the actual output level, expressed in volts, follows the dB rating, it is unlikely that the rating will be misinterpreted. By this convention we have not created a new unit, we have merely endeavoured to avoid the imprecision of existing, widely used dB ratings. There is no substitute for a thorough understanding of the mathematics behind dB relationships, but such a discussion is beyond the scope of this manual.

For additional information, refer to these books:

"Sound System Engineering"

"The Audio Cyclopaedia"

OHM'S LAW

Ohm's law relates voltage, current and resistance in a DC circuit by the following equation:

$$V = IR$$

(Where V is voltage, I is current, and R is resistance.)

Other forms of Ohm's law, derived by simple algebraic manipulation, are:

$$I = V/R$$

$$R = V/I$$

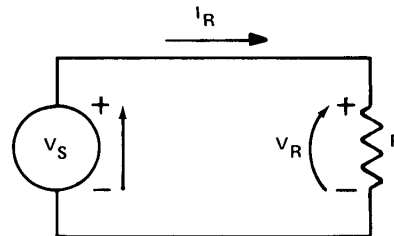

For this Simple Circuit, the Voltage produced by the Source V_S equals the Voltage across the Resistor V_R .

The Voltage across and Current through the Resistor are related by Ohm's law:

$$V_R = I_R \times R$$

The Power Dissipated in the Resistor is:

$$P_R = V_R^2 \div R$$

OR

$$P_R = I_R^2 \times R$$

OR

$$P_R = V_R \times I_R$$

Fig. 71 – Ohm's Law

POWER

In a DC circuit, the power absorbed by a resistor is given by the following equation:

$$P = VI$$

(Where V and I are the voltage and current through the resistor, and P is the power dissipation.)

By using Ohm's law and some algebraic manipulation again, we come up with two alternate forms of the power equation:

$$P = V^2/R$$

$$P = I^2 \times R$$

A "perfect" voltage source would always produce the same voltage, regardless of the load resistance, and would be capable of an infinite current into a short circuit (zero ohms resistance). A "perfect" current source would always produce the same current, regardless of the load resistance, and would be capable of an infinite voltage into an open circuit (infinite ohms resistance, or no connection).

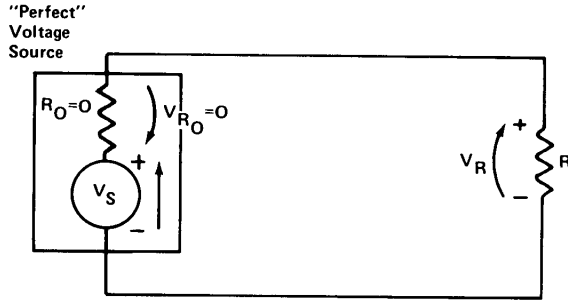

The Voltage across the Resistor is Equal to the Source Voltage:

$$V_R = V_S$$

because there is no voltage drop across the source's zero-ohm output resistance.

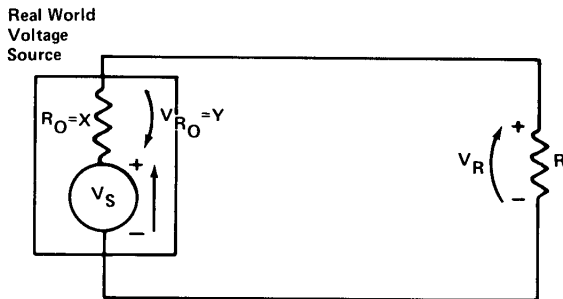

The Voltage across the Resistor is Less Than the Source Voltage due to the voltage drop across the output resistor R_O :

$$V_R = V_S \left(\frac{R}{R + R_O} \right)$$

NOTE: X is the output resistance (or impedance) of the source. Y is the voltage drop across the output resistance which varies depending on other circuit parameters.

Fig. 72 – Voltage Sources.

IMPEDANCE

Impedance is the total opposition to the flow of alternating current in a circuit. An *impedance* is made of a pure resistance combined with a *reactance*. The reactance itself consists of a capacitance, and inductance, or some combination of the two. A "pure" resistance maintains the same value, in ohms, whether the voltage or current changes from a DC source to an AC source at any frequency. On the other hand, the value of an impedance, in ohms, changes with frequency, making it more challenging to manipulate mathematically.

"Pure" circuit components, such as a perfect voltage source, a perfect current source, or a pure resistance, do not exist in the real world. However, the P2050 can be considered to be a perfect voltage source because it behaves in this manner *within its specified operating limits*. Similarly, a source such as a mixer that is feeding the P2050 can be considered to be a perfect voltage source in series with a pure resistance, that pure resistance being equal to the mixer's output impedance. In some cases, even a speaker impedance can be considered to be a pure resistance, although in other cases the variation with frequency of a speaker's impedance must be considered. The behavior of audio circuits is more easily explained by making these and other such assumptions.

To illustrate a typical simplifying assumption, consider the fact that any impedance can be treated as a pure resistance having a simple ohmic value, so

long as only one frequency is used. However, single frequencies are not representative of audio sources, except for test tones. This is a good place to make a simplifying assumption: assume the impedances that we work with in audio can be treated like pure resistances over the entire audio frequency range. In most cases, this is a good assumption, and we have used it throughout this manual. When the occasional exception shows up, we have treated it separately. If we had to deal with an actual impedance value, made up of a pure resistance and a reactance, most of the formulas we use would be similar, but would contain complex numbers with a real and imaginary part. This would be a lot more complicated, and not very much more accurate than the simple ohmic values one works with in the simplified equations.

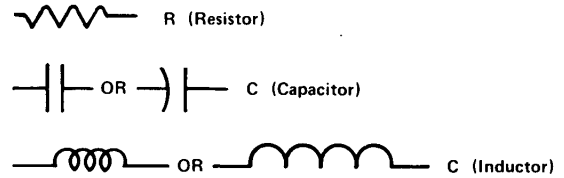

An "Impedance" is some combination (one, two, three or more components connected together in a circuit) of Resistors, Capacitors and Inductors.

Fig. 73 – Elements of an Impedance

SERIES AND PARALLEL IMPEDANCE CONNECTIONS

Figure 74 diagrams the differences between series and parallel connected impedances. The total impedance, Z_T , of a set of series connected impedances is simply their algebraic sum. The total impedance of a set of parallel connected impedances is given by the following formula:

$$Z_T = \frac{1}{1/Z_1 + 1/Z_2 + 1/Z_3 + 1/Z_4 \dots \text{etc.}}$$

When there are only two impedances connected in parallel, the formula can be simplified to:

$$Z_T = \frac{Z_1 \times Z_2}{Z_1 + Z_2}$$

If the two impedances are the same ohmic value, the formula further simplifies to:

$$Z_T = Z/2$$

This final simplified formula is valid for any number (N) of parallel impedances *provided that their ohmic values are all the same*:

$$Z_T = Z/N$$

To calculate the power dissipated in any of the impedances (any branch) of the circuits of Figure 74, simply find the voltage across that impedance or the current through the impedance using the voltage and current division rules that follow. Alternately, find both the voltage and the current in that branch. Then use the power formulas developed on Page EIGHT 2. Note that if all the impedances shown in any one of the circuits in Figure 74 are the same, the power dissipated in each of those equal impedances is also the same: one-fourth of the total power dissipated.

EIGHT 4

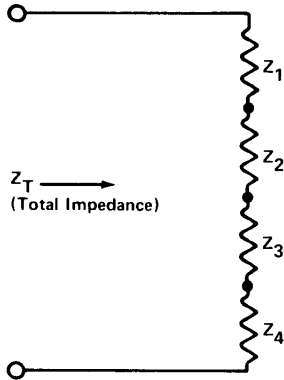

Series Connected Impedances.

$$Z_T = Z_1 + Z_2 + Z_3 + Z_4$$

(See Text)

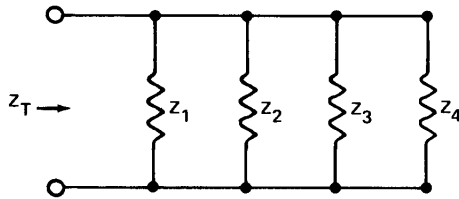

Parallel Connected Impedances.

$$Z_T = \frac{1}{\frac{1}{Z_1} + \frac{1}{Z_2} + \frac{1}{Z_3} + \frac{1}{Z_4}}$$

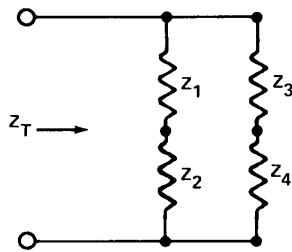

Series/Parallel Connected Impedances.

$$Z_T = \frac{1}{\frac{1}{(Z_1 + Z_2)} + \frac{1}{(Z_3 + Z_4)}} = \frac{(Z_1 + Z_2)(Z_3 + Z_4)}{Z_1 + Z_2 + Z_3 + Z_4}$$

OR

$$Z_T = (Z_1 + Z_2) \parallel (Z_3 + Z_4) \text{ (|| Means: "In Parallel With")}$$

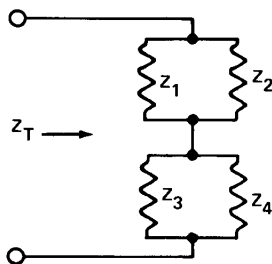

Parallel/Series Connected Impedances

$$Z_T = \left(\frac{Z_1 Z_2}{Z_1 + Z_2} \right) + \left(\frac{Z_3 Z_4}{Z_3 + Z_4} \right) \text{ OR } Z_T = Z_1 \parallel Z_2 + Z_3 \parallel Z_4$$

Fig. 74 – Series and Parallel Impedances

VOLTAGE AND CURRENT DIVISION

When two or more impedances are connected in series across a voltage source, they share the voltage among themselves according to the following formulas, where N is the number of impedances: (see Figure 75)

For two impedances:

$$V_{Z_1} = V_S \left(\frac{Z_1}{Z_1 + Z_2} \right)$$

For any number (N) of impedances:

$$V_{Z_1} = V_S \left(\frac{Z_1}{Z_1 + Z_2 + Z_3 + \dots + Z_N} \right)$$

If the ohmic value of all the impedances is the same, they share the voltage equally:

$$V_{Z_1} = \frac{V_S}{N}$$

When two or more impedances are connected in parallel across a voltage source, they each receive the same voltage, regardless of their ohmic value.

$$V_{Z_1} = V_{Z_2} = \dots = V_{Z_N} = V_S$$

If the source is a current source, series connected impedances all receive the same current:

$$I_{Z_1} = I_{Z_2} = \dots = I_{Z_N} = I_S$$

Parallel connected impedances share the current from a current source according to the following formula:

For two impedances:

$$I_{Z_1} = I_S \left(\frac{Z_2}{Z_1 + Z_2} \right)$$

For any number (N) of impedances:

$$I_{Z_1} = I_S \left(\frac{Z_2 + Z_3 + \dots + Z_N}{Z_1 + Z_2 + Z_3 + \dots + Z_N} \right)$$

Once voltage or current is known, power can be calculated from the formulas on Page EIGHT 2.

In audio, most sources can be treated as voltage sources, whether they are power amplifiers, microphones, mixers, etc. By considering these devices as voltage sources in series with their own output impedance, all of the formulas for Ohm's law and voltage and current division can be applied, with few exceptions.

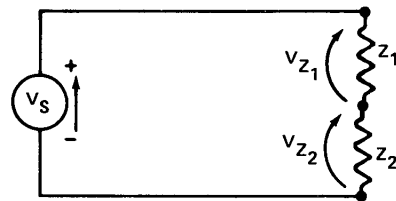

Voltage Division between Two Series Connected Impedances:

$$V_{Z_1} = V_S \left(\frac{Z_1}{Z_1 + Z_2} \right); V_{Z_2} = V_S \left(\frac{Z_2}{Z_1 + Z_2} \right)$$

Fig. 75 – Voltage and Current Division
(Continued on next page)

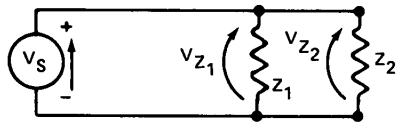

Voltage is the same for Two Parallel Connected Impedances regardless of their Impedance Values.

$$V_{Z_1} = V_{Z_2} = V_s$$

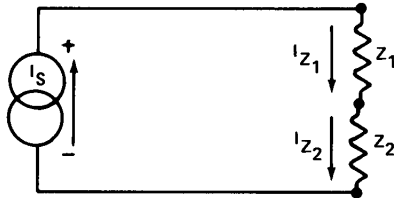

Current is the same for Two Series Connected Impedances regardless of their Impedance Values.

$$I_{Z_1} = I_{Z_2} = I_s$$

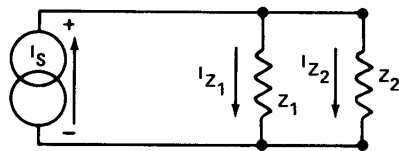

Current Division between Two Parallel Connected Impedances:

$$I_{Z_1} = I_s \left(\frac{Z_2}{Z_1 + Z_2} \right); I_{Z_2} = I_s \left(\frac{Z_1}{Z_1 + Z_2} \right)$$

BALANCED, UNBALANCED AND FLOATING CIRCUITS

Unbalanced, balanced and floating circuits may all be transformer isolated. The distinction between them lies in the way the circuits are referenced to ground (audio common). A **FLOATING** circuit has no ground reference, as illustrated by the Yamaha PM-180, PM-430, and PM-700 Mixers' channel inputs and XLR outputs. A **BALANCED** circuit requires either a center tapped transformer, or resistors from each side of the transformer to ground; either condition places both sides of the transformer at equal potential with respect to ground. In other words, the transformer is *balanced* with respect to ground. Electronic balancing, done with

"differential" input or output circuits, can replace transformers, with similar results. For example, the output of the P2050 in the "mono" mode is balanced electronically. Figure 76 shows transformer-created balanced, floating and unbalanced lines.

Consider what happens if an RF source (radio station, CB radio, SCR dimmer, etc.) causes a noise current in the wires of a balanced circuit. Provided that the source is physically distant from the circuit, compared to the distance between the two wires, RF will cut across both wires, creating equal noise voltages in both wires. However, since the signals (wanted voltage) in the two wires are out of phase with each other, the in-phase noise (unwanted voltage) is effectively canceled.

A balanced line may or may not have a shield. If it does have a shield, the shield is usually at the same voltage potential as the common or ground wire. Since the phase cancellation of noise currents in a balanced line is never perfect in the real world, most low level balanced circuits, mic or line level, are shielded. Twisting the two internal wires also helps cancel noise.

A *floating* line is also a two wire circuit, one which is usually created by a transformer. However, unlike a balanced line, the common or ground voltage has no direct connection to the circuit. Even so, a floating line will reject hum and noise as well as a balanced line, and is often used for audio applications.

TRANSFORMERS

Several applications of audio transformers are discussed in specifics on Pages SIX 4 and SIX 5; the following paragraphs concern general transformer operation.

A transformer changes electrical energy at its input (primary winding) into magnetic energy in its core. This magnetic energy is transformed back into electrical energy at the transformer's output (secondary winding). If the transformer is wound with a greater number of turns on its primary side than on its secondary side, the voltage level at the secondary will be lower than on the primary, and the current level on the secondary will be higher than on the primary. Since the impedance of a circuit is equal to the ratio of that circuit's voltage level divided by its current level, a transformer can transform impedances as well as voltages and currents. These actions take place in a precise, mathematical way described by the equations on the next page.

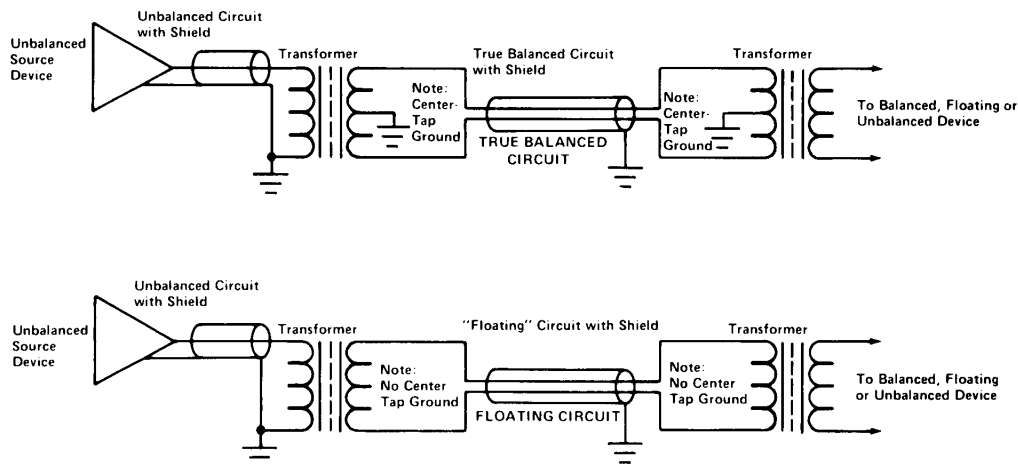

Fig. 76 — Balanced vs Floating Circuits

EIGHT 6

NOTES:

" N_1 " is the number of turns on the primary side of the transformer, " N_2 " is the number of turns on the secondary side of the transformer.

" V_1 " is the voltage level on the primary side of the transformer, " V_2 " is the voltage level on the secondary side of the transformer.

" I_1 " is the current level on the primary side of the transformer, " I_2 " is the current level on the secondary side of the transformer.

" Z_1 " is the impedance of the circuit seen at the primary side of the transformer, " Z_2 " is the impedance seen at the secondary side of the transformer.

Equations:

1. $V_1 / V_2 = N_1 / N_2$
2. $I_1 / I_2 = N_2 / N_1$
3. $Z_1 / Z_2 = [N_1 / N_2]^2$

Equation 1 shows that the voltage ratio between the primary and secondary windings of a transformer is directly proportional to the transformer's turns ratio. This equation is applicable to voltage level matching between two circuits.

Equation 2 shows that the current ratio between the two windings of the transformer is *inversely* proportional to the turns ratio.

Equation 3 describes the impedance matching action of a transformer. Note that the impedance ratio between the primary and secondary of the transformer is directly proportional to the *square* of the turns ratio.

Often, the transformer spec sheet gives its impedance ratio, but not its turns ratio. A simple manipulation of Equation 3 solves this problem:

$$4. N_1 / N_2 = \sqrt{Z_1 / Z_2}$$

Consider the following example:

A transformer has a primary impedance of 15k-ohms, and a secondary impedance of 600 ohms. If the input (primary) voltage is -16dB (0.123 volts), what is the output voltage?

$$\begin{aligned} \text{From Equation 4: } N_1 / N_2 &= \sqrt{15,000/600} \\ &= \sqrt{25} = 5 \end{aligned}$$

Since $N_1 / N_2 = V_1 / V_2$ (Equation 1), then:

$$5 = (0.123 \text{ volts}) / V_2, \text{ or } V_2 = (0.123 \text{ volts}) / 5$$

$$\text{Answer: } V_2 = 24.6\text{mV} = -30\text{dB}$$

From this example, transforming a -16dB (0.123 volts) hi-fi output, with a source impedance of 15k-ohms, to a professional input with an input impedance of 600-ohms also drops the level a full 14dB to -30dB (24.6mV).

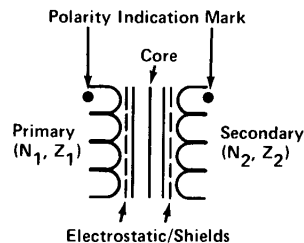

Fig. 77 – Typical Audio Transformer

OTHER CONSIDERATIONS

A transformer actually doesn't *have* any impedance of its own. It merely transforms an impedance at its primary to a corresponding impedance at its secondary as described in Equation 3. Thus, the transformer in the above example has an impedance ratio of 15,000:600 which equals 25:1. If a 150k-ohm circuit is connected to its primary, the impedance seen at the secondary will be $150,000/25 = 6000$ ohms. Since this impedance transformation works in both directions, if a 6000-ohm circuit is connected to the secondary of the transformer, the impedance seen at the primary will be 150,000-ohms. Voltage and current matching also work in both directions.

However, a transformer that is specified as having an impedance ratio of 15,000 ohms-to-600 ohms has been manufactured specifically to transform those impedances. If it is used with circuits having considerably greater or smaller impedances, its frequency response may be degraded, or it can "ring" (resonate). One way to overcome this problem is to terminate the transformer with its rated impedance as discussed on Page SIX 2.

It is also important to use a transformer at the voltage and power level for which it was planned. For example, a mic level transformer will probably saturate (distort) if it is used for line level circuit matching. Also, a line level transformer will not perform properly if it is used for mic level circuit matching. The magnetic fields are so weak that non-linearity occurs. Whenever possible, pick a transformer for each use according to the voltage levels, power levels, and the impedances of the circuits under consideration.

One other significant use of audio transformers is to isolate the ground wire of one circuit from another to prevent ground loops and reduce hum. The discussion of balanced lines on Page EIGHT 5, and the grounding discussion on Page SIX 13 expand this concept.

Speaker level transformers (constant voltage speaker transformers, and auto-transformers) are discussed on Page SEVEN 6.

POWER
ON/PUSH OFF

YAMAHA

PROFESSIONAL SERIES

NATURAL SOUND POWER AMPLIFIER
MODEL P2050

▪ OFF
▪ ON

SINCE 1887



YAMAHA

NIPPON GAKKI CO., LTD. HAMAMATSU, JAPAN

LOM-212 79705 & Printed in Japan